

PROFIBUS DP / LWL

coupler 2. generation

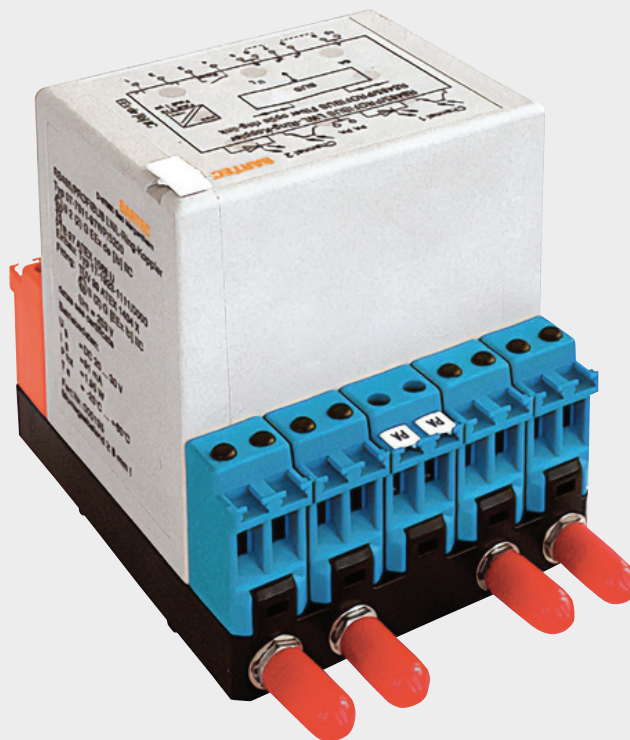

Control and regulation components MODEX

PROFIBUS DP / LWL coupler. Type 07-7311-97WP

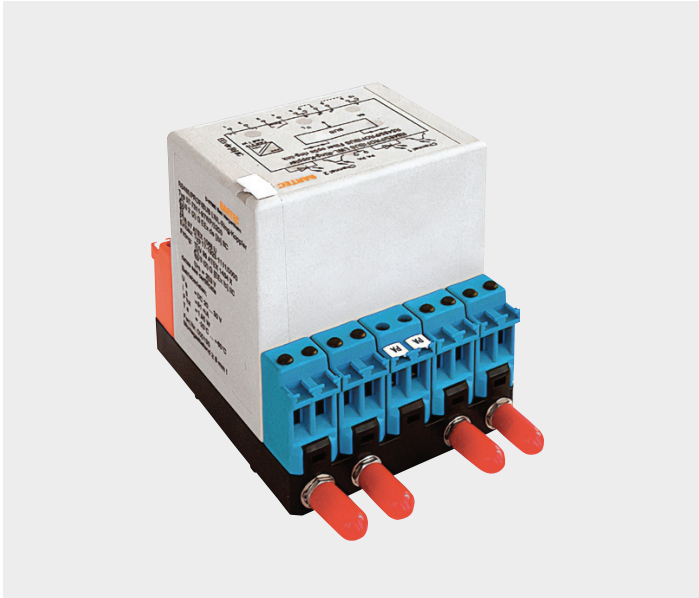

Definition

The PROFIBUS LWL - coupler reroutes the PROFIBUS from copper conductors to optical waveguides. The coupler is a passive bus participant and are suitable for hazardous areas of zone 1 and 21. In plants, the PROFIBUS LWL - coupler allows the bridging of great distance with PROFINET without noise interference.

- Ring-coupler, P-P-coupler, T-coupler
- Automatic master/slave detection
- Automatic build rate detection
- Fiberview for fibre optic ring monitoring

The electronics for the signal conversion are accommodated in the flameproof MODEX enclosure. Transmitter and receiver for the LWL-coupler are intrinsically safe headed. The intrinsically safe control transmitter and receiver of the electronic system guarantee that the transmitter rate does not go beyond maximum value limits.

Configuration

The interface modules of the LWL coupler serve the active coupling of RS485 two-wire bus lines, particularly the Profibus-DP or Profibus-FMS with optical wave-guide transmission paths.

With applicable documents

- Declaration of EU conformity
- Test certificates

These documents must be retained!

Intended Use

The PROFIBUS LWL - coupler are designed to meet the industrial requirements in hazardous (potentially explosive) areas.

Industrial Requirements of Zone 1

The modules are approved as “Ex d flameproof enclosures” with connecting terminals in “Ex e increased safety ex e”. Since the open connecting terminals are Ex e, the modules are given a partial certificate with the “U” marking.

Special note concerning the “U” marking

The modules must be installed in an enclosure that meets the requirements of a recognised type of protection in accordance EN/IEC 60079-0, min. protection type IP54. When installing in an enclosure with “increased safety ‘e’”, the clearance and creep age distances in Tables 1+2 in IEC/EN 60079-7 must be complied with.

Intrinsically safe installed components

If installed components with intrinsically safe circuits are produced as associated apparatus, they undergo their own type examination by a notified body. These are marked with an “X” after the test number.

The “X” indicates that special conditions apply to this device in the test certificate. These conditions can be read in the test certification.

Use in local control stations

Local control stations may generally be opened for testing and adjustment work. Work may be carried out on intrinsically safe circuits if all non-intrinsically safe circuits have an internal cover which, when the enclosure is open, corresponds to at least the following protection class IP 30 when the enclosure is open.

Typ

| | | |
|------------------|-----------------------------|------|
| 07-7311-97WP6500 | Profibus LWL P-P - Coupler | FSMA |
| 07-7311-97WP6510 | Profibus LWL P-P - Coupler | ST |
| 07-7311-97WP4500 | Profibus LWL T- Coupler | FSMA |
| 07-7311-97WP4510 | Profibus LWL T- Coupler | ST |
| 07-7311-97WP5500 | Profibus LWL Ring - Coupler | FSMA |
| 07-7311-97WP5510 | Profibus LWL Ring - Coupler | ST |

Explosionsschutz

| | |
|---------------|----------------|
| Marking ATEX | Ⓜ Zone 1/21 |
| Certification | see bartec.com |
| Marking IECEx | Zone 1/21 |
| Certification | see bartec.com |
| Marking CSA | Class I Zone 1 |
| Certification | see bartec.com |

Further approvals and test certificates can be found at bartec.com

EU Conformity

| | |
|---|--|
| RoHS Directive | 2011/65/EU |
| Standards in accordance with EMC Directive 2014/30/EU | EN/IEC 61000-6-2:2005 EN 61000-6-4:2007 + A1:2011 IEC 61000-6-4:2006 + A1:2010 |
| Product labelling | 0044 |
| Product labelling installation | CE 0044 |

Technical Data

| Physical characteristics | |
|--|---|
| Construction | flameproof clip-on enclosure |
| Enclosure material | high-quality thermoplastics |
| Protection class (EN/IEC 60529) | IP20 (minimum) IP66 |
| Terminals | IP30 |
| Electronic module | |
| Terminals with cover | |
| Electric connections | terminals 2.5 mm ² , fine-stranded |
| Attachment onto mounting rail (EN/IEC 60715) | TH 35 x 15 (7.5) |
| Operating | LED Green: Operation indicator (ON) BA: LED green flashing: Bus activity LED red: no communication FV1 and FV2: LED Red: No connection LED Red/green=yellow: Light output borderline LED Green: Connection OK LED green or yellow flashing: Data reception Declaration: FV = Fiberview BA = BUS activity |
| Terminal marking | inscription label |
| Terminal screws | M 2.5 x 0.45 mm |
| Terminal screw torque | 0.4 Nm |
| Mounting position | any |
| Weight | approx. 600 g |
| Dimensions | 94 x 91 x 75 mm |

PROFIBUS



Technical Data

| Ambient conditions | |
|--------------------------------|--|
| Ambient temperature | -25 °C to +60 °C at T4 |
| Storage/transport temperature | -40 °C to +70 °C |
| Relative Luftfeuchtigkeit | 5 % to 95 % non-condensing |
| Vibration (EN 60068-2-6) | 2 g/7 mm, 5-200 Hz in all 3 axes |
| Shock (EN 60068-2-27) | 15 g, 11 ms in allen 3 Achsen |
| Electrical Data | |
| Galvanic isolation | Bus//power supply//optical waveguide |
| Bus input/output | 2-wire remote bus with screw terminals |
| Optical waveguide input/output | FSMA LWL plug-in connectors ST LWL plug-in connectors |
| Supply voltage | L+, L- DC 20 V to DC 30 V |
| Bit distortion | 60 ns (max.) |
| Power consumption dissipation | max. 3.0W |
| Signal delay | max. 4,5 µs/typ. 3.4 µs and 5 ns per meter fibre optic |
| Current consumption | approx. 125 mA at DC 24 V |
| Distance/Optical budget | |
| Fiber/glass | approx. 2.000 m 50/125 µm 4 dB approx. 3.000 m 62.5/125 µm 8 dB |
| Terminating resistor | Terminating resistor |

Dimensions / mounting positions

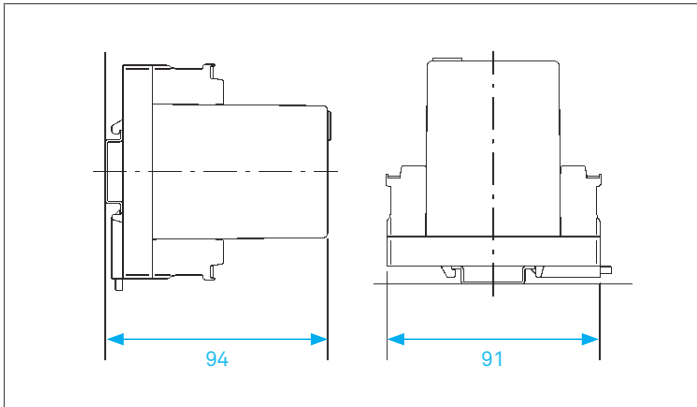

Marking

Particularly important points in these instructions are marked with a symbol:

| | |
|--|--|
| | DANGER indicates a hazardous situation which, if not avoided, will result in death or serious injury. |
| | WARNING indicates a hazardous situation which, if not avoided, could result in death or serious injury. |
| | CAUTION indicates a hazardous situation which, if not avoided, could result in minor or moderate injury. |
| | NOTICE is used to address practices not related to personal injury. |
| | NOTE Important instructions and information on effective, economical and environmentally compatible handling. |

Transport and storage

| | |
|--|---|
| | <p>NOTICE</p> <p>Damages due to improper storage!</p> <ul style="list-style-type: none"> • Observe storage and transport temperatures. • Condensation can arise on components in a cold environment. • Use the original packaging for transport/storage. |
|--|---|

Installation

| | |
|--|--|
| | <p>NOTICE</p> <p>Damage due to improper handling!</p> <ul style="list-style-type: none"> • Assembly, disassembly, installation and commissioning may only be performed by qualified personnel who are authorized and trained to assemble electrical components in hazardous areas. <p>Plugs:</p> <ul style="list-style-type: none"> • The plugs are difficult to pull off! Due to the high fitting accuracy of plug and socket, a vacuum is created during removal, which requires higher removal forces. For this reason, the plugs must be pulled off carefully to avoid damaging the plugs and connectors. |
|--|--|

| | |
|--|--|
| | <p>DANGER</p> <p>Improper use, incorrect assembly and operation can operation endanger the explosion protection and can lead to and can lead to serious personal injury or damage to property.</p> |
|--|--|

The following special conditions must be heeded!

1. Do not install and commission components that have been stored in a cold environment. Take condensation into consideration!
2. The enclosure has been sealed in the factory. The enclosure must not be opened!
3. Before installation, check whether the components are in perfect condition.
4. No conversions or changes to the module may be made.
5. Only work on the module when it is voltage-free
6. Units must be mounted at a distance of 8 mm from the to the nearest unit.
7. All screws and terminals must be tightened using a torque wrench, taking account of the recommended connection torque for screws and terminals of 0.4 Nm to 0.7 Nm. Suitable measures must be taken to ensure this.
8. Ensure the unit is dead (be aware of consumers with stored energy)
9. Cover any live neighbouring components.
10. The PA connection part must be connected with low impedance to the equipotential bonding conductor of the hazardous area. Since the intrinsically safe circuits are galvanically connected to ground potential, equipotential bonding of the intrinsically safe circuits must be maintained throughout the service life of the system.
11. Decommission the device in the event of a fault.

Bus termination

As a basic rule, the BUS must be terminated at the beginning and at the end of the bus segment. If an LWL coupler is connected at the beginning or at the end of the segment, it is possible to terminate the BUS with the aid of an internally fitted bus termination.

The devices are terminated by two electrical jumpers from terminal 9 (A) to terminal 8 (Ax) and from terminal 7 (Bx) to terminal 6 (B) (see terminal connection).

Projection of optical circle

Calculation of the circle-time:

- t_{Ring} = max. ring circle time (n-1) * $t_{Ring-coupler} + l * t_{Fibre\ optic}$
- n = number of LWL couplers in ring
- $t_{Ring-coupler}$ = running time module - running time at Ring coupler = 4.5 ms
- l = Length of fibre at ring
- $t_{Fibre\ optic}$ = running time per metre Ring coupler = 5 ns

The following values obtain:

| Data rate Kbit/s | Running time | Max. distance between 2 Ring coupler |
|------------------|--------------|--------------------------------------|
| 1 500 | 0.30 ms | 0.7 km |
| 500 | 0.90 ms | 2.2 km |
| 187.5 | 2.40 ms | 2.6 km |
| 93.75 | 4.80 ms | 2.6 km |
| 45.45 | 9.90 ms | 2.6 km |
| 19.2 | 23.44 ms | 2.6 km |
| 9.6 | 46.88 ms | 2.6 km |

Installation

Installation and commissioning may only be carried out by qualified personnel who are authorized and trained to install electrical components in potentially explosive atmospheres.



DANGER

Exposed live parts. Danger to life due to electric shock!!

- Only work on the module when it is de-energised state.



CAUTION

Infrared light! Danger to eyesight!

- Do not look into the laser beam of the transmitter
- In the event of a malfunction, put the device out of operation!

Wiring diagram / terminal assignment

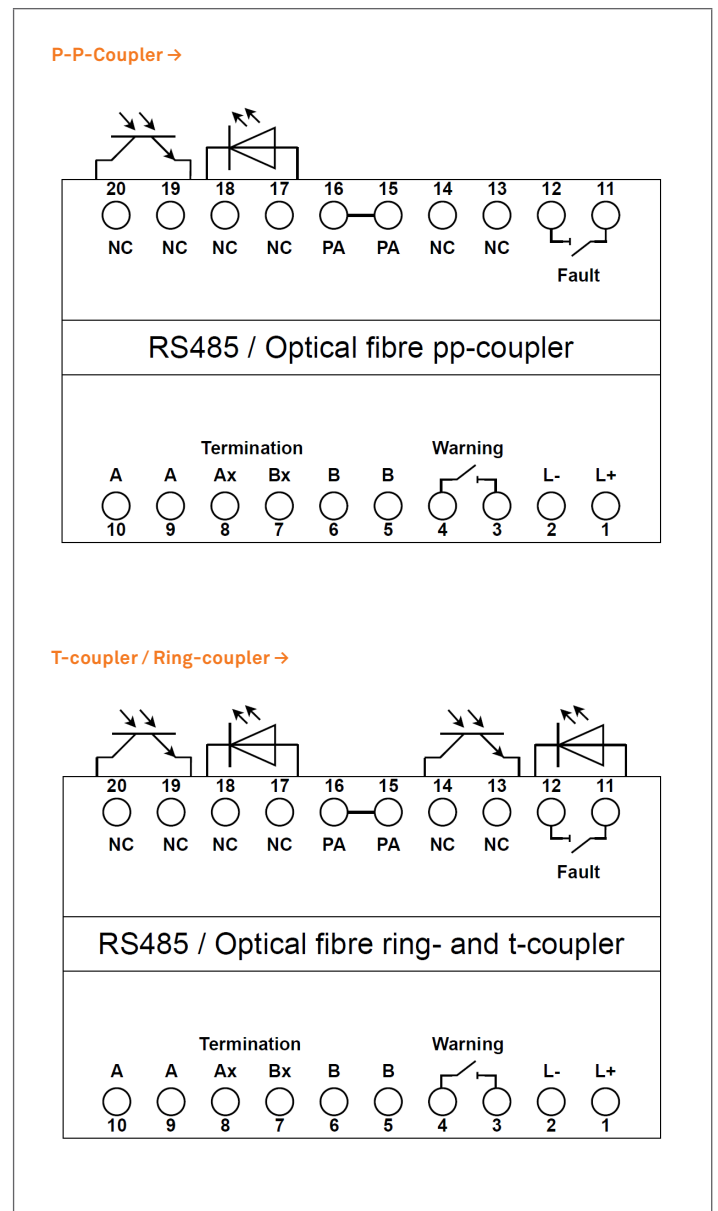

Terminal connection

| Terminal | Name |
|----------|--------------------------|
| 1 | (+) DC 24 V Power supply |
| 2 | (-) DC 24 V Power supply |
| 3 | Warning relay contact 1 |
| 4 | Warning relay contact 2 |
| 5 | (Termination) B |
| 6 | (Termination) B |
| 7 | (Termination) Bx |
| 8 | (Termination) Ax |
| 9 | (Termination) A |
| 10 | (Termination) A |

| Terminal | Name |
|----------|-----------------------|
| 11 | Fault relay contact 1 |
| 12 | Fault relay contact 2 |
| 13 | NC |
| 14 | NC |
| 15 | PA |
| 16 | PA |
| 17 | NC |
| 18 | NC |
| 19 | NC |
| 20 | NC |

Work steps

- Check the correct wiring of the fiber optic coupler before commissioning.
- The terminal devices to be connected by means of optical fibers must be switched off and de-energized. Snap the fiber optic coupler onto the TS35 mounting rail and check that the device is held securely.
- Activate the necessary terminating resistors at the beginning and end of the bus.
- Lay the FO cable according to the data sheet. Otherwise, the cable may be damaged and/or the communication between the FO ring couplers may no longer be guaranteed. Observe the routing instructions from your FO manufacturer.

Commissioning

Check before commissioning:

1. Has the module been installed correctly?
2. Is the enclosure undamaged?
3. Has the connection been carried out correctly?
4. Have you checked that the wiring is correct?
5. Does the module function correctly?
6. PA properly connected to equipotential bonding conductor

Operation

After the final inspection has been carried out, the device can be put into operation.

DANGER

There is a danger to life if the device is not used as intended!

- Observe the special conditions for explosion protection.
- Operate only within the permitted temperature range.
- Connect PA properly to equipotential bonding conductor.
- In the event of bus failure (communication error), the outputs go into fail-safe mode (go to 0 and are switched off!).

Troubleshooting

Troubleshooting during connection Establishment

7. Are the FO systems supplied with voltage?
8. Is the correct connection between the FO coupler and the terminal device ensured and has the correct interface been selected?
9. Are all screw terminals correctly tightened?
10. Is one optical transmitter connected to the optical receiver of the opposite device at a time (cross connection)?
11. Are the bus terminating resistors activated and have they been correctly selected and connected?
12. Is the transmission distance not too long?
13. Is the transmission rate correct and was the data rate set according to „Project planning“?
14. Have the guidelines for the individual modules of the software been observed?
15. Has the FO cable been laid correctly?
16. Are FO systems of other manufacturers in the ring? Only use BARTEC systems!

Maintenance, Inspection, Repair

Only authorised and qualified personnel may do any work on the control and regulating component.

Maintenance

If operated correctly in accordance with the installation instructions and ambient conditions, it does not require maintenance.

Inspection

Under EN/IEC 60079-17 and EN/IEC 60079-19 the owner/ managing operator of electric installations in hazardous areas is obliged to have these installations checked by a qualified electrician to ensure that they are in a proper condition.

Repair

The component cannot be repaired. Please contact BARTEC GmbH if you have any questions.

Disposal

The regulating and control components contain metallic and plastic parts and electronic parts.



NOTE

Our devices involve electrical equipment which is only intended for commercial use (so-called B2B equipment in accordance with the WEEE Directive).

The regulating and control components must be disposed of in accordance with national regulations.

Our customers may return any products procured from us to our company for disposal. The sender must bear the costs for shipping/packing.

Amendments to the Document

BARTEC GmbH reserves the right to change the contents of this document without notification. We assume no guarantee for the correctness of the information. In cases of doubt the German safety instructions apply because it is not possible to rule out errors during printing and translation. The „General Terms and Conditions of Business“ of the BARTEC Group moreover apply in the event of legal disputes.

The current version of data sheets, operating instructions, certificates and EC declarations of conformity can be downloaded from bartec.com or directly requested from BARTEC GmbH.

Order numbers

| | | |
|----------------------------|------|------------------|
| Profibus LWL P-P- Coupler | FSMA | 07-7311-97WP6500 |
| Profibus LWL P-P- Coupler | ST | 07-7311-97WP6510 |
| Profibus LWL T- Coupler | FSMA | 07-7311-97WP4500 |
| Profibus LWL T- Coupler | ST | 07-7311-97WP4510 |
| Profibus LWL Ring- Coupler | FSMA | 07-7311-97WP5500 |
| Profibus LWL Ring- Coupler | ST | 07-7311-97WP5510 |

Serviceadresse

BARTEC GmbH
 Max-Eyth-Str. 16
 97980 Bad Mergentheim
 Germany

Phone: +49 7931 597-0
 info@bartec.com



Coupling example

P-P-coupler →

Connection example of optical fibre / Profibus pp-coupler

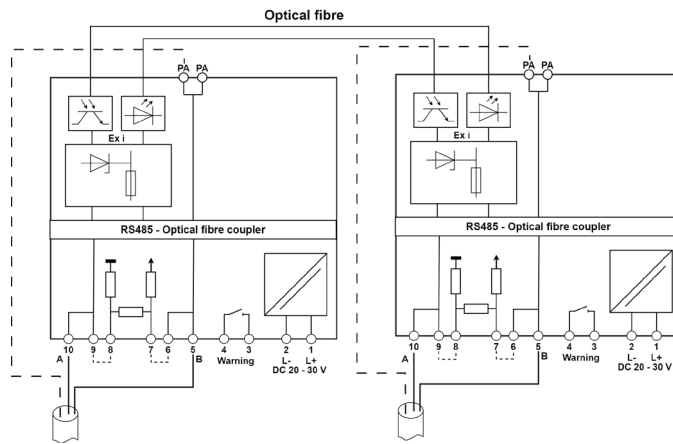

T-coupler →

Connection example of optical fibre / Profibus t-coupler

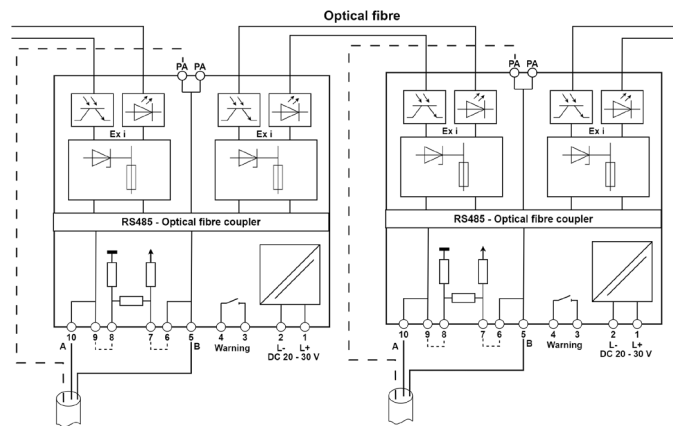

Ring-coupler →

Connection example of optical fibre / Profibus ring-coupler

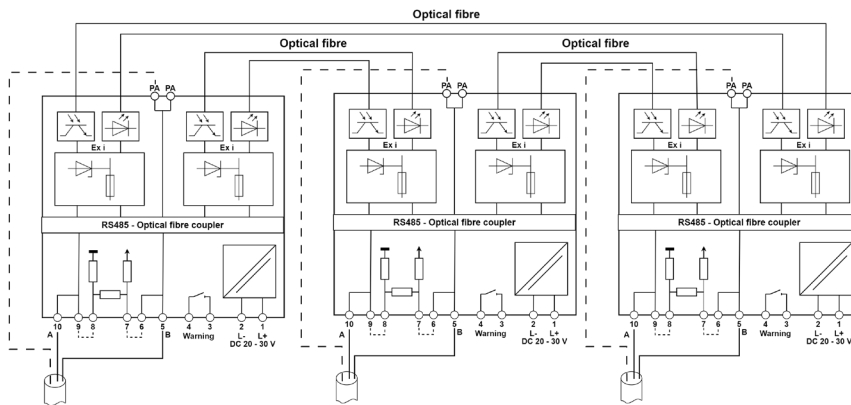

The following values apply:

| Fiber | Core/ Cladding | Incoupling power * | Receiver overmodulation limit | Receiver undermodulation limit | Typical fiber damping | Typical distance | Optical budget |
|-------|-------------------|-----------------------|----------------------------------|-----------------------------------|--------------------------|---------------------|-------------------|
| Glass | 50/125 µm | -18.2 dBm | -10 dBm | -32 dBm | -3 dB/km | 2000 m | 6 dB |
| Glass | 62.5/125 µm | -14.5 dBm | -10 dBm | -32 dBm | -3 dB/km | 3000 m | 9 dB |

* The measured values in the table correspond to the peak values. The pertinent average values amount to -3 dBm.

Konformitätserklärung
 Declaration of Conformity
 Déclaration de conformité
 N° 01-7311-7C0030_C



| Wir | We | Nous |
|---|--|--|
| BARTEC GmbH Max-Eyth-Straße 16 97980 Bad Mergentheim Germany | | |
| erklären in alleiniger Verantwortung, dass das Produkt Steuer- und Regel-Komponente | declare under our sole responsibility that the product Control Component | attestons sous notre seule responsabilité que le produit Composants de commande et de regulation |

07-7311-**/******

| | | |
|--|---|--|
| auf das sich diese Erklärung bezieht den Anforderungen der folgenden Richtlinien (RL) entspricht ATEX-Richtlinie 2014/34/EU EMV-Richtlinie 2014/30/EU RoHS-Richtlinie 2011/65/EU und mit folgenden Normen oder normativen Dokumenten übereinstimmt | to which this declaration relates is in accordance with the provision of the following directives (D) ATEX-Directive 2014/34/EU EMC-Directive 2014/30/EU RoHS-Directive 2011/65/EU and is in conformity with the following standards or other normative documents | se référant à cette attestation correspond aux dispositions des directives (D) suivantes Directive ATEX 2014/34/UE Directive CEM 2014/30/UE Directive RoHS 2011/65/UE et est conforme aux normes ou documents normatifs ci-dessous |
|--|---|--|

EN 60079-0:2018
EN 60079-1:2014
EN 60079-7:2015
EN 60079-11 :2012

EN 61000-6-2:2005
EN 61000-6-4:2007 + A1:2011
EN 60529:1991+A1:2000+ A2:2013

| | | |
|--|---|--|
| Verfahren der EU-Baumusterprüfung / Benannte Stelle | Procedure of EU-Type Examination / Notified Body | Procédure d'examen UE de type / Organisme Notifié |
|--|---|--|

PTB 97 ATEX 1068 U

0102, PTB, Bundesallee 100, 38116 Braunschweig, DE

0044

Bad Mergentheim, 10.11.2021

i.V. Reiner Englert

Product Manager Automation

Kevin Rogers

Head of Global R&D ESS

BARTEC

BARTEC GmbH
Max-Eyth-Str. 16
97980 Bad Mergentheim
Germany

Phone: +49 7931 597-0
info@bartec.com

bartec.com