

PLEXO TCS

Installation and Operation

Heating cable connection, splice and end termination system with BARTEC self limiting heating cables Type PSB and MSB

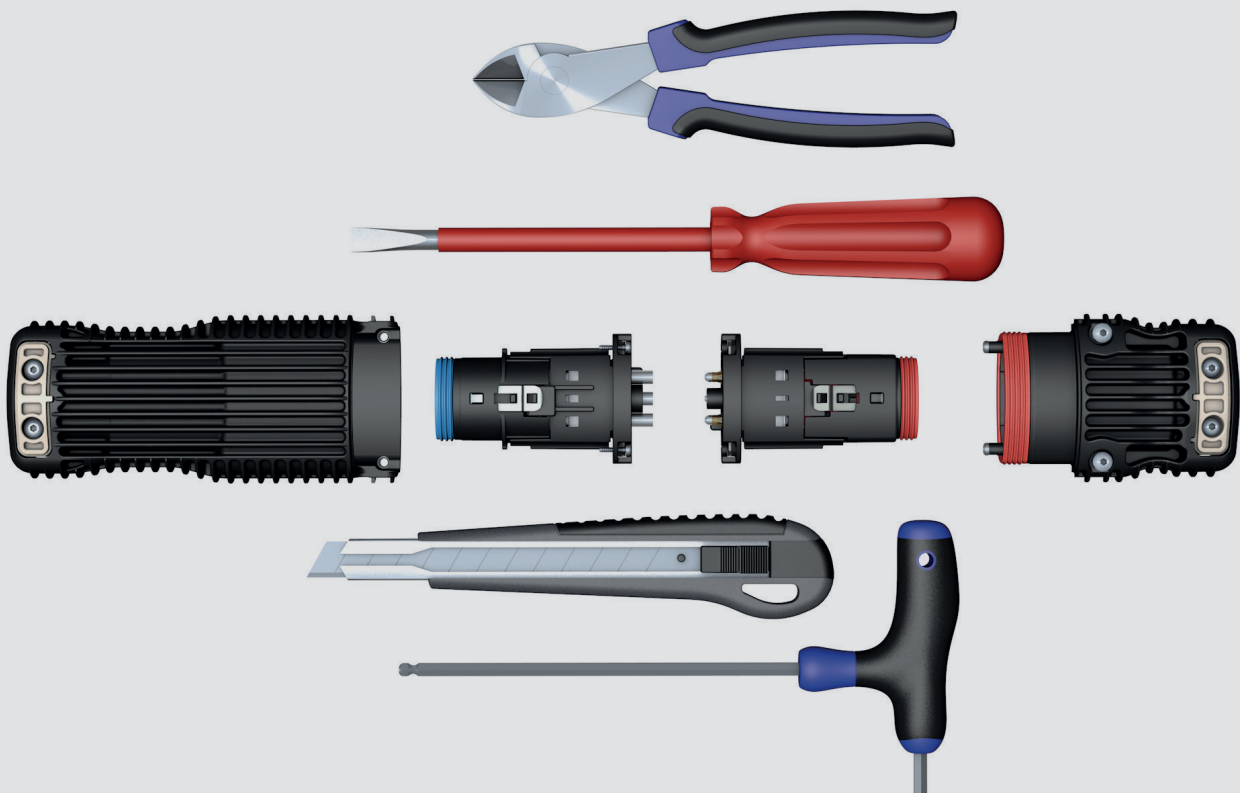

1. Intended Use

1.1 General Points

When operated in accordance with the intended purpose, the PLEXO TCS Type 27-1100-..../.... Ex a heating system, consisting of a PLEXO TCS plug connector (heating cable supply connection, end termination or splice) and the BARTEC self-limiting PSB and MSB parallel heating cables can be used as a stationary system in hazardous (potentially explosive) areas in which an explosive atmosphere of gas, vapour, mist or a dust/air mixtures can be expected to develop sometimes.

It is used in Zones 1, 2, 21 or 22 in accordance with the certified explosion group II and the specified temperature classes.

1.2 Usable Plug-In Connectors

Version	Use
Supply connection Type 27-59P1-..../....	The connection serves as a joining element between the mains cables/sheathed cables and heating cables.
Splice connection Type 27-59P2-..../....	The splice serves to join heating cables together.
End termination Type 27-59P3-..../....	The end termination serves as an explosion-proof end termination for heating circuits which facilitate length extensions.

1.3 Usable Heating Cables

The following heating cables can be used in the PLEXO TCS heating system:

- PSB heating cables, type 07-5853-....
DEKRA 17ATEX/0007 U / IECEx DEK 17.0004U
- MSB heating cables, type 07-5854-....
DEKRA 17ATEX/0007 U / IECEx DEK 17.0004U

2. Product Description

2.1 General Points

The PLEXO TCS heating system is suitable for use with BARTEC self-limiting heating cables. The modular PLEXO TCS plug connector allows a heating cable connection, splice or end termination to be assembled easily and safely. The PLEXO TCS connectors can be plugged in and are produced with patented sealing and clamping technology.

Overview of heating system types

27-1100-*** ***50
 A B

A	Rated voltage range of heating cable	110 V to 120 V 208 V to 254 V	0 1
B	Heating cable family used	PSB MSB	1 2

2.2 Heating Cable Connection (Type 27-59P1-...../.....)

Overview of heating cable connection types

Type	Description	Oval sealing A (for heating cables)		Round sealing B (for supply cables)	
		Colour	Sealing area	Colour	Sealing area
27-59P1-101./....	Heating cable connection	orange	PSB, MSB heating cables	yellow	$9 \leq D \leq 10$ mm
27-59P1-201./....				beige	$10 \leq D \leq 12$ mm
27-59P1-301./....				orange	$12 \leq D \leq 14$ mm
27-59P1-401./....				blue	$14 \leq D \leq 16$ mm

Overview of heating cable connection parts

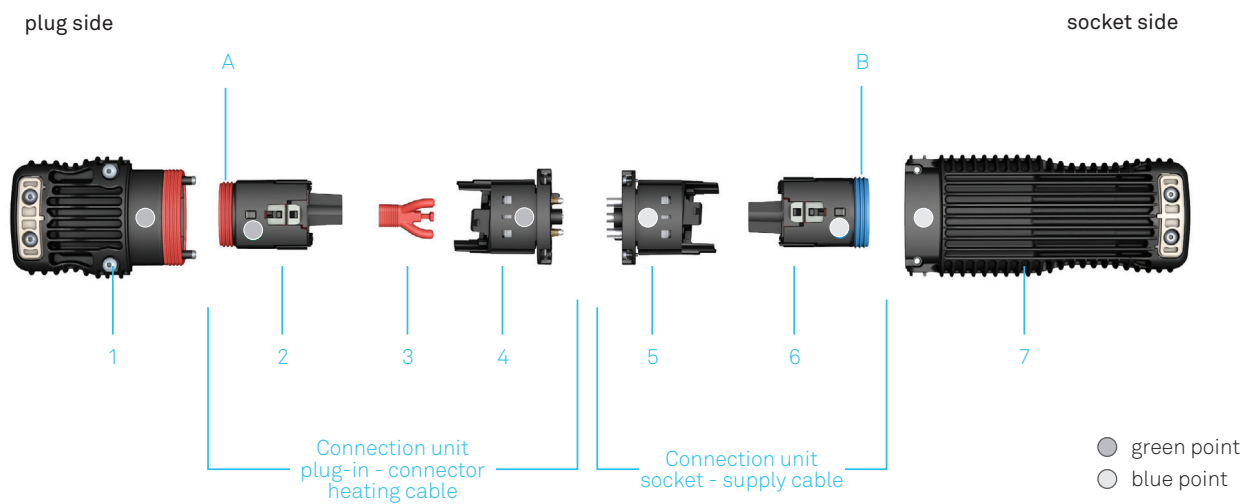

1	Heating cable housing
2	Heating cable sealing unit
3	Insulating divider
4	Heating cable clamping unit
5	Supply cable clamping unit
6	Supply cable sealing unit
7	Supply cable housing
A	Heating cable sealing
B	Supply cable sealing
2-4	Connection unit plug-in - connector heating cable
5-6	Connection unit socket - supply cable

2.3 Heating Cable Splice (Type 27-59P2-...../....)

Overview of heating cable splice types

Type	Description	Oval sealing A (for heating cables) Colour	Sealing area
27-59P2-011./....	Heating cable splice	orange	PSB, MSB heating cables

Overview of heating cable splice parts

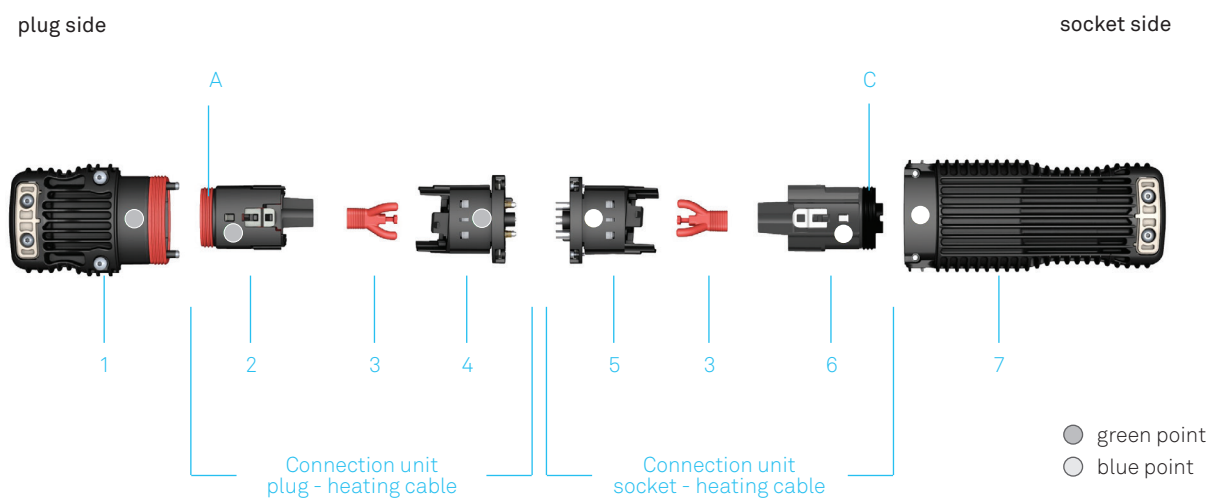

1	Heating cable housing
2	Heating cable sealing unit
3	Insulating divider
4	Heating cable clamping unit
5	Heating cable splice clamping unit
6	Heating cable splice sealing unit
7	Heating cable splice housing
A	Heating cable sealing
C	Heating cable sealing
2-4	Connection unit plug - heating cable
5-6	Connection unit socket - heating cable

2.4 Heating Cable End Termination (Type 27-59P3-...../.....)

Overview of heating cable end termination types

Type	Description	Oval sealing A (for heating cables)	
		Colour	Sealing area
27-59P3-001./....	End termination	orange	PSB, MSB heating cables

Overview of heating cable splice parts

plug side

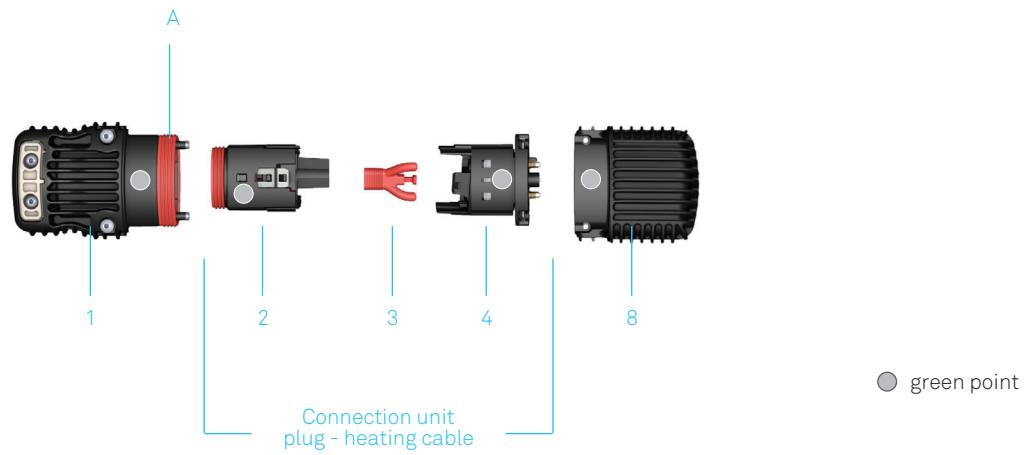







1	Heating cable housing
2	Heating cable sealing unit
3	Insulating divider
4	Heating cable clamping unit
8	End termination housing
A	Heating cable sealing
2-4	Connection unit plug - heating cable

3. Safety Instructions

Marking

Particularly important points in these instructions are marked with a symbol:

	DANGER signs draw attention to a danger which will lead to death or serious injury if not avoided.
	WARNING sign draws attention to a danger which can lead to death or serious injury if it is not avoided.
	CAUTION sign draws attention to a danger which can lead to injuries if it is not avoided.
	ATTENTION sign draws attention to measures to prevent damage to property.
	NOTE Important instructions and information on effective, economical & environmentally compatible handling.

	WARNING
	<ul style="list-style-type: none"> To prevent any life-threatening injuries and damage to property occurring when the PLEXO TCS system is used, it is important that all users read these Operating and Installation Instructions carefully and observe and apply them. The PLEXO TCS heating system may be used only within the limits specified in the technical data. The PLEXO TCS plug-in connector must not be opened while the heating circuit is energized as there is then a risk of life-threatening injuries and damage to property. The heating circuit or device must be completely disconnected from the mains if there is a chance of live parts being touched during work. The outer jacket of the PLEXO TCS plug-in connector may be cleaned with a damp cloth only as there is a potential risk of electrostatic discharging if a dry cloth is used.

	CAUTION
	<ul style="list-style-type: none"> When electrical systems are used in hazardous areas the relevant installation and operating rules (e.g. Directive 1999/92/EG, Directive 2014/34/EU, IEC/EN 60079-14, IEC/EN 60079-17 and the DIN VDE series 0100) and the specifications on the type label must be observed. Conductive parts from other components must be incorporated into the (protective conductor) safety measures to provide protection against indirect contact. The general points in the applicable statutory rules and other binding directives on workplace safety, accident prevention and environmental protection must be complied with. Always follow the safety instructions. For each electric circuit a residual-current circuit-breaker and a means of isolating all supply conductors from the current supply must be provided.

CAUTION

- The middle terminal must always be used for the protective earth (earthing). The splicing must always be incorporated in the PE conductor safety measures. A device to protect against earth faults in accordance with the system earthing must be used. The protective braiding on the heating cable must be connected to the supply cable's protective earth conductor (see IEC/EN 60079-30-1, Section 4.3).
- When installing the PLEXO TCS plug-in connector, the tightening torques specified in these operating instructions must be observed.
- Whenever you carry out assembly or servicing work, always check the affected sealings visually for damage and make sure they are positioned correctly.
- Installation and commissioning may be done only by trained specialized personnel in conformance to the manufacturer's specifications and the applicable installation standards.
- Maintenance and troubleshooting measures may be performed only by authorized people, qualified personnel or electricians. Before starting operation again, check conformance with the applicable laws and directives. The respective safety instructions must be observed when doing maintenance work or troubleshooting.
- Stop operation, assembly or maintenance if there are discrepancies between the PLEXO TCS operating instructions and the technical documents or design documents and/or the situation on site and consult BARTEC.

ATTENTION

- Utilisation in areas other than those specified or the modification of the product by anyone other than the manufacturer is not permitted and will exempt BARTEC from liability for defects or any further liability.
- The acceptance test report for the heating system operation must be filled in completely and signed (see Chapter 9). The requirements in the separately certified BARTEC heating cables must be observed in accordance with the operating instructions. For claims under guarantee the submission of a correctly and completely filled-in acceptance and test report is mandatory.
- The owner/managing operator of an electrical system in a hazardous environment must keep the equipment in an orderly condition, operate it in accordance with regulations, monitor it and do the required maintenance and repairs (IEC/EN 60079-14, IEC/EN 60079-17, IEC/EN 60079-19, IEC/EN 60079-30-1, Section 4.3). The correct functioning of the PLEXO TCS heating system must be checked at the in-spection intervals specified in the German Ordinance on Industrial Safety and Health (BetrSichV).
- Optional temperature monitoring and control units may be used only within the limits of the specified technical data (see marking, type label and acceptance test report).
- The classification of the temperature class of the heating system is done from the operator depending in the used heating cable. The ambient temperature range of the heating system depends also of the used heating cable. This information recorded on the operator side accordance with the specifications in this operating instructions/acceptance report. The documentation must be kept sure.

4. Technical data

4.1 PLEXO TCS Heating system

System Type 27-1100-..../....

Rated voltage	Max. 254 V, the data for the parallel heating cable must be observed
Rated connection capacity	0.5 - 4 mm ²
Maximum heating circuit length of the system	In conformance to the specifications in the type examination certificate/IECEX approval for the respective heating cable family (The values specified there refer to the fuse rating/minimum cut-in temperature).
Degree of protection in conformance to IEC EN 60529	IP 65 (IEC EN 60079-0); IP 66, IP 68 (IEC EN 60529)

System Type 27-1100-.1../.... (with PSB heating cables)

Maximum fuse rating of the system	32 A
Ambient temperature range	-55 °C ≤ Ta ≤ +65 °C for system in T5, T6
Minimum temperature resistance of supply cable (connection with PSB heating cable)	+80 °C for system in T5 +75 °C for system in T6

System Type 27-1100-.2../.... (with MSB heating cables)

Maximum fuse rating of the system	32 A
Ambient temperature range	-60 °C ≤ Ta ≤ +110 °C for system in T3, T4
Minimum temperature resistance of supply cable (connection with MSB heating cable)	+125 °C for system in T3 +95 °C for system in T4

4.2 PLEXO Plug-In Connectors

PLEXO Plug-In Connectors

Rated voltage	320 V
Rated connection capacity	0.5 - 4 mm ²
Working temperature range	- 60 °C ≤ T ≤ +160 °C
Area of use of PLEXO plug-in connector with heating cables	PSB heating cables, Type 07-5853-.... DEKRA 17ATEX/0007 U/IECEX DEK 17.0004U MSB heating cables, Type 07-5854-.... DEKRA 17ATEX/0007 U/IECEX DEK 17.0004U
Sealing area for supply cables	9 ≤ D ≤ 16 mm (for Types 27-59P1-..../....)

5. Characteristics

5.1 PLEXO TCS heating systems (types 27-1100-..50)

PLEXO TCS heating system with PSB heating cables (type 27-1100-*150)

PLEXO plug-in connectors	Max. fuse	Heating cable family	T class system	Max. surface temperature system	Heating cable type	Operating temperature of heating cable $T_{min.} - T_{max.}$	Ambient temperature PLEXO plug-in connectors $Ta_{min.} - Ta_{max.}$	Temperature resistance supply cable (min.)	Type PLEXO TCS System
21-59P1-*010	32 A	PSB	T6	80 °C	07-5853-710*	$-55\text{ °C} \leq T \leq +65\text{ °C}$	$-55\text{ °C} \leq Ta \leq +65\text{ °C}$	+75 °C	27-1100-0150
					07-5853-715*				
					07-5853-110*				
			T5	95 °C	07-5853-115*				
					07-5853-725*				
					07-5853-733*				
21-59P2-0110 21-59P3-0110	32 A	PSB	T6	80 °C	07-5853-125*	$-55\text{ °C} \leq T \leq +65\text{ °C}$	$-55\text{ °C} \leq Ta \leq +65\text{ °C}$	-	27-1100-0150
					07-5853-133*				
					07-5853-710*				
			T5	95 °C	07-5853-715*				
					07-5853-110*				
					07-5853-115*				

PLEXO TCS heating system with MSB heating cables (types 27-1100-*250)

PLEXO plug-in connectors	Max. fuse	Heating cable family	T class system	Max. surface temperature system	Heating cable type	Operating temperature of heating cable $T_{min.} - T_{max.}$	Ambient temperature PLEXO plug-in connectors $Ta_{min.} - Ta_{max.}$	Temperature resistance supply cable (min.)	Type PLEXO TCS System
21-59P1-*010	32 A	MSB	T4	130 °C	07-5854-110*	$-60\text{ °C} \leq T \leq +110\text{ °C}$	$-60\text{ °C} \leq Ta \leq +110\text{ °C}$	+125 °C	27-1100-1250
					07-5854-710*				
					07-5854-115*				
			T3	170 °C	07-5854-715*				
					07-5854-130*				
					07-5854-730*				
21-59P2-0110 21-59P3-0110	32 A	MSB	T4	130 °C	07-5854-145*	$-60\text{ °C} \leq T \leq +110\text{ °C}$	$-60\text{ °C} \leq Ta \leq +110\text{ °C}$	-	27-1100-1250
					07-5854-745*				
					07-5854-160*				
			T3	170 °C	07-5854-760*				
					07-5854-110*				
					07-5854-710*				

5.2 Explosion Protection

Explosion Protection

Standards ATEX:	EN IEC 60079-0:2018, EN 60079-30-1:2017, EN 60079-7:2015 + A1: 2018, EN 60079-31:2014
Standards IECEX:	IEC 60079-0:2017, IEC IEEE 60079-30-1:2015, IEC 60079-7: 2017 IEC 60079-31-1:2013
System marking on the PLEXO	PLEXO TCS system Type (e) 27-1100-**50/**** (1)
Plug-in connector - PSB	II 2 G Ex eb 60079-30-1 IIC T5, T6 Gb ⁽²⁾ II 2 D Ex tb 60079-30-1 IIIC T95 °C, T80 °C Db ⁽²⁾
- MSB	II 2 G Ex eb 60079-30-1 IIC T6, T5, T4, T3 Gb ⁽²⁾ II 2 D Ex tb 60079-30-1 IIIC T80°C...T170°C Db ⁽²⁾
Plug-in connector	PSB heating cables, Type 07-5853-.... DEKRA 17ATEX/0007 U/IECEX DEK 17.0004U MSB heating cables, Type 07-5854-.... DEKRA 17ATEX/0007 U/IECEX DEK 17.0004U
Testing laboratory/certification	BVS 13 ATEX E 040 X
IECEX Certificate	IECEX BVS 13.0048X
EAC Certification	EA9C RU C-DE.BH02.B.00403/20 Ex The EAC hazardous location marking is done in the user manual respectively on the packaging label. Not enough space is available on the product marking label.
Additional information	⁽²⁾ T-class, ambient temperature range see special conditions for use of EC type examination certificate and ⁽¹⁾ design documentation.

5.3 Marking

Metal type plate and laser engraving on the front side: contains all information relating to the PLEXO TCS heating system. The heating system serial number assigned by the installer must be inscribed permanently on the type plate with a pen suitable for that purpose.

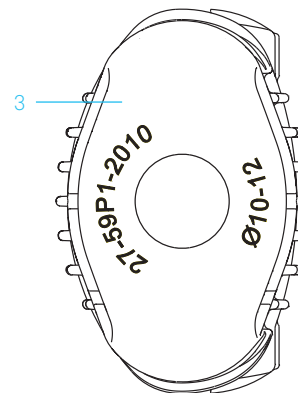
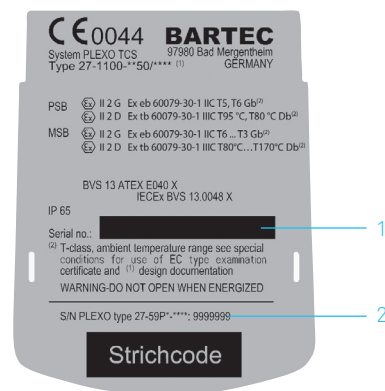

1	PLEXO heating system serial number
2	PLEXO plug-in connector serial number
3	Type PLEXO plug-in connector

6. Assembly/Installation

NOTE

- Workstation, trace heating element holder, power supply cable, self-limiting parallel heating cables and PLEXO plug-in connector must be dry, clean and free of ice or condensate.
- The plug-in connector assemblies must not be taken out of the original packaging until the point of time of installation. Sealing parts must not be bent or damaged.
- Before installing connections to the self-limiting parallel heating cables and before commissioning, check the electrical resistance between the active supply conductors and the protective braiding or other suitable, electrically conductive material (see IEC/EN 60079-30-2, Section 8.3.4). A minimum test voltage of DC 500 V requires a resistance level of at least 20 MΩ. A test voltage of a maximum DC 2500 V is recommendable.



For PLEXO TCS heating systems which are to be used in hazardous environments the following minimum requirements must be observed (see IEC/EN 60079-30-1, Section 4.3.):

- There must be a means of disconnecting the mains cable from the supply.
- Overcurrent protection must be provided for each branch circuit.
- There must be a device which provides protection against earth faults in accordance with the system earthing (for definitions see IEC 60364-3).
- The copper braiding must be used as a protective earth conductor (see IEC/EN 60079-30-1, Section 4.3.).

NOTE

Always observe the directions in the installation and operating instructions for BARTEC type 07-580.-.... self-limiting parallel heating cables. You will find information there on the maximum heating circuit length and on suitable dimensions for power circuit-breakers. Please refer to the illustrations in Chapters 2.2 to 2.4. for the positions of the components described in the following. The following tools at least are necessary for assembling the PLEXO plug-in connector:



Tools

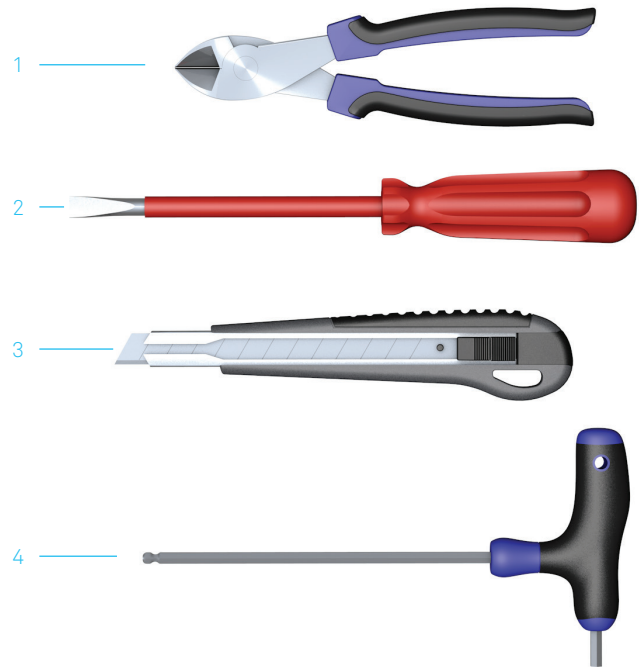

1	Cable cutter (for cable diameters 8 - 16 mm)
2	Screwdriver (max. blade width 5.5 mm)
3	Cable stripping knife
4	Hex key (size 2.5 mm)

Connection socket side (PLEXO plug-in connector Type 27-59P1-....)

Use a screwdriver to loosen the supply cable connection unit if this part has been assembled already. Pull the supply cable connection unit out of the supply cable housing.

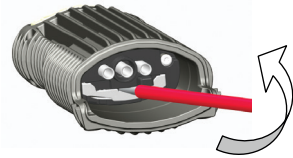

1

Make sure that the sliding elements in the individual terminals are in the OPEN position.

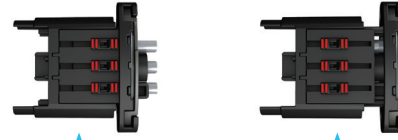

Sliding element in the CLOSED position

Sliding element in the OPEN position.

5

The supply cable connection unit is composed of the sealing unit and terminal unit together.

Open the retaining spring by lifting it carefully with a screwdriver and in this way separate the sealing unit from the terminal unit.

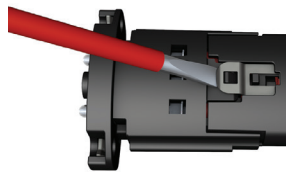

2

Insert the connection strands simultaneously as far as they will go into the supply cable's clamping unit. Look through the inspection holes on the opposite side to check if the strands are positioned correctly.

The strands must be inspected visually to make sure that they have been inserted completely through the cage clamp terminals inside. Press the sliding element for the individual terminals from the OPEN position into the CLOSED position.

Push the sealing unit and clamping unit carefully together until the retaining spring locks into place.

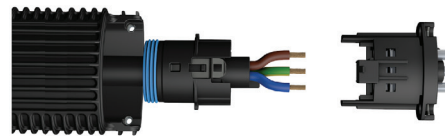

6

Push the power supply cable through the supply cable housing and the sealing unit. The internal diameter and the colour of the sealing depend on the selected dimensions for the supply cable. See also Chapter 2.



3

Push the connection unit back into the housing until it audibly clicks into place in the enclosure. Use the guiding devices on both sides and press against the clamping unit while inserting in the direction of the cable entry at the enclosure.

The screw heads in the housing on the socket side must be completely visible after the latching. Never remove or loosen the two screws inside the enclosure.

Close the strain relief by tightening the strain relief screws evenly with a torque of 1.2 Nm.

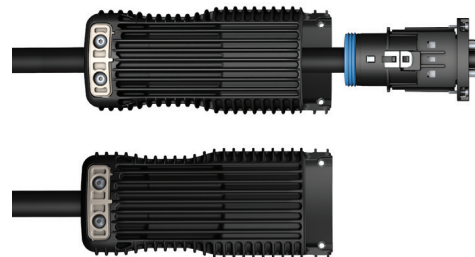

7



NOTE

Do not twist the pre-assembled connection unit while or before pushing it into the housing as this could cause a short-circuit.

Once the supply cable has been inserted, it must be prepared for connection: Cut the supply cable with a straight cut. Remove the outer jacket from the power supply cable so that the central strand (earthing) is 35 mm long. Strip 8 mm of insulation from the individual cable strands. Twist the conductors, and adjust them.



4

Connection plug side (PLEXO plug-in connector type 27-59P1-..., type 27-59P2-..., type 27-59P3-...)

Use a screwdriver to release the heating cable connection unit from the plug housing if this part has already been assembled. Pull the heating cable connection unit out of the heating cable connector housing.

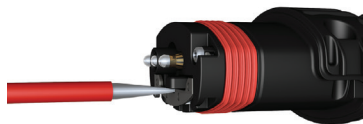

1

The heating cable connection unit is composed of the sealing unit and clamping unit together. Open the retaining spring by carefully lifting it with a screwdriver and in this way separate the sealing unit from the terminal unit.

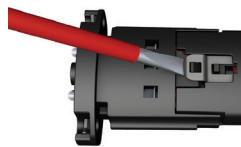

2

Push the heating cable through the plug housing and the sealing unit. See also Chapter 2.

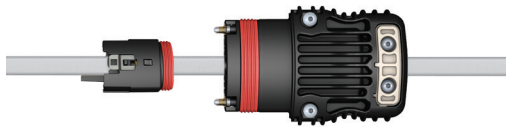

3

NOTE

When preparing the heating cable strands, do not cut off or damage the individual wires as this could reduce the cross-section. Suitable tools must be used. Do not cut into the insulating divider. If necessary, repeat this step until a visual inspection confirms that it has been done correctly.

Once the heating cable has been introduced, it must be prepared for connection:



4

Cut the heating cable with a straight cut. Remove 53 mm from the outer jacket.



Adjust the BARTEC heating cable metal braiding and twist it. A length of 50 mm must be cut off the braiding that is formed.



Remove 40 mm of the internal insulation and of the matrix so that the supply conductors are exposed. Then cut the two supply conductors to a length of 30 mm and twist them.

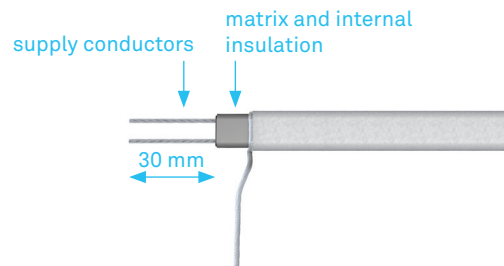

4

Insert the two supply conductors simultaneously into the insulating divider. Use the two insertion tubes, which are required only for this step (to guide the flexible strands through the insulating divider). Once the strands have been inserted successfully, the two insertion tubes are removed again by pulling them in the direction of the end of the strand.

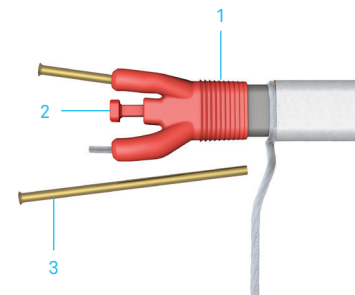

- 1 Insulating divider
- 2 Plunger
- 3 Insertion tube

5

Push the insulating divider as far as it will go onto the heating cable. After that, by pressing in the plunger, seal the heating cable matrix with insulating gel.

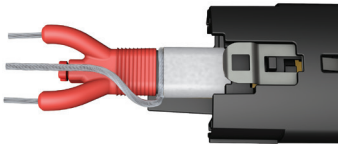

6

Make sure the sliding elements in the individual terminals are in the OPEN position.

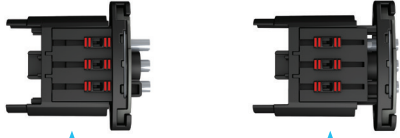

↑ Sliding element in the CLOSED position
 ↑ Sliding element in the OPEN position.

7

Take care when connecting the conductors at the clamping unit that the insulating divider is in the correct position relative to the clamping unit and the sealing unit. The colour markings on the individual assemblies will help here.

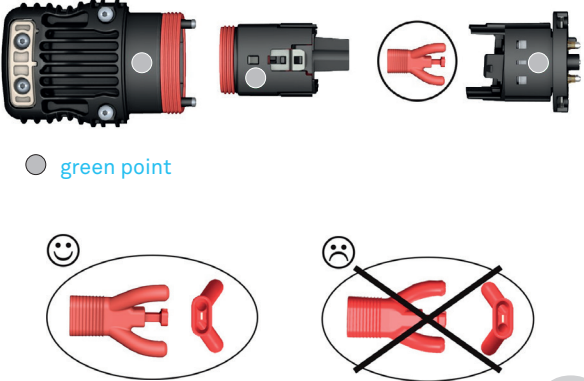

● green point

8

Insert the two preassembled heating cable supply conductors into the holes in the external terminals. Always insert the twisted protective braiding into the central terminal. Look through the inspection holes on the opposite side to check if the strands are positioned correctly.

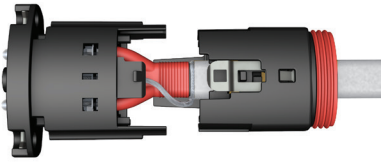

9

The strands must be inspected visually to see if they have been introduced through the cage clamp terminals inside. Push the sliding elements for the individual supply conductor terminals from the OPEN position into the CLOSED position.

Push the sealing unit and the clamping unit carefully together until the retaining spring locks into place.



10

Push the connection unit back into the housing until it audibly clicks into place in the housing. Use the guiding devices on both sides and, while inserting, press against the clamping unit in the direction of the cable entry on the enclosure.



11

The screw heads in the housing on the socket side must be completely visible after locking into place. Never remove or loosen the two screws inside the enclosure.

Close the strain relief by tightening the strain-relief screws evenly with a torque of 1.2 Nm.

Connection socket side (PLEXO plug-in connector type 27-59P2-....)

Use a screwdriver to release the heating cable connection unit socket from the plug housing if this part has been assembled already. Pull the heating cable connection unit socket out of the heating cable plug housing.

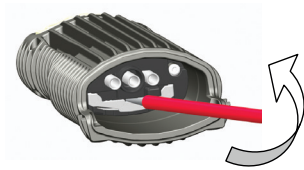

1

The heating cable connection unit is composed of the sealing unit and clamping unit together.

Open the retaining spring by carefully raising it with a screwdriver and in this way separate the sealing unit from the clamping unit.

Push the heating cable through the plug housing and the sealing unit.

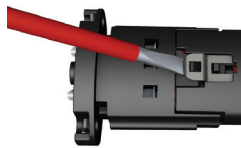

2

NOTE



When preparing the heating cable strands, the individual wires must not be cut off/damaged in case that would reduce the cross-section. Use suitable tools. Do not cut into the insulating divider. If necessary, repeat the step until a visual inspection confirms that it has been done properly.

Once the heating cable has been inserted, it must be prepared for connection:



3

Cut the heating cable with a straight cut. Remove 53 mm of the outer jacket.



Adjust the metal braiding on the BARTEC heating cables and twist it. A length of 50 mm must be cut off the braiding that is formed.



Remove 40 mm of the internal insulation and of the matrix so that the supply conductors are exposed. Then cut the two supply conductors to a length of 30 mm and twist them.

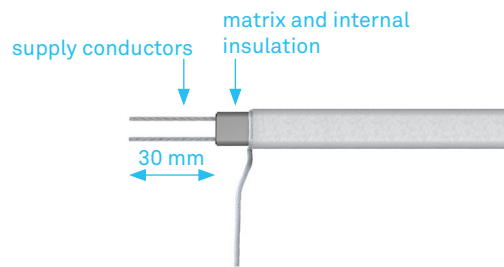

3

Insert the two supply conductors simultaneously into the insulating divider. Use the two insertion tubes, which are needed only for this step (to guide the flexible strands through the insulating divider). Once the conductors have been inserted correctly, pull off the two insertion tubes again in the direction of the strand end.

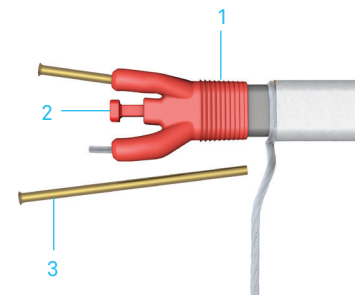

- | | |
|---|--------------------|
| 1 | Insulating divider |
| 2 | Plunger |
| 3 | Insertion tube |

4

Push the insulating divider as far as it will go onto the heating cable. Then, press in the plunger to seal the heating cable matrix with insulating gel.

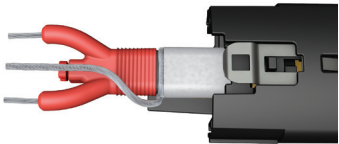

5

Make sure the sliding elements in the individual terminals are in the OPEN position.



↑ Sliding element in the CLOSED position
 ↑ Sliding element in the OPEN position.

6

When connecting the conductors to the terminal unit, make sure that the insulating divider is in the correct position relative to the clamping unit and sealing unit. The colour markings on the individual assemblies will help you with this.

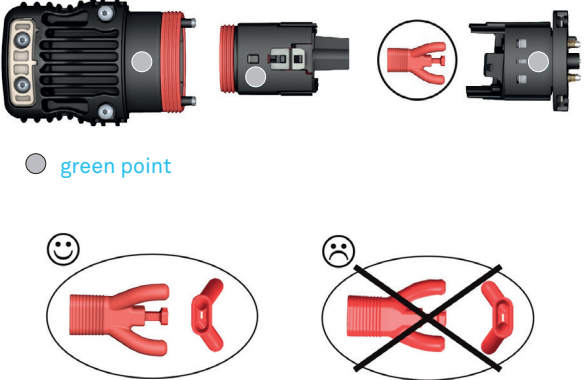

● green point

Insert the two pre-assembled supply conductors for the heating cable into the holes in the external terminals. The twisted protective braiding must be inserted into the middle terminal always. Look through the inspection holes on the opposite side to see if the strands are positioned correctly.

The strands must be inspected visually. Make sure they have been inserted through the cage clamp terminals inside. Push the sliding elements for the individual supply conductor terminals from the OPEN position into the CLOSED position.

7

Push the sealing unit and clamping unit together carefully until the retaining spring locks into place.

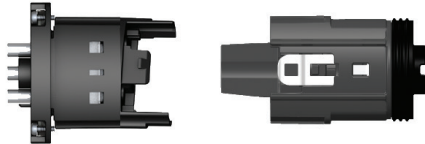

8

Push the connection unit back into the housing until it audibly clicks into place in the housing. Use the guiding devices on both sides and press against the clamping unit while inserting in the direction of the cable entry on the housing.

The screw heads in the housing on the socket side must be completely visible after the latching. Never remove or loosen the two screws inside the enclosure.

Close the strain relief by tightening the strain relief screws evenly with a torque of 1.2 Nm.

Close the PLEXO plug-in connector (PLEXO plug-in connector type 27-59P.-....)

The PLEXO plug-in connector assembly is identical for all types. Bring the plug side (plug housing) and the socket side (socket housing) or, as the case may be, the end termination housing as closely together as possible.

Close the safety interlock by using the hex key to tighten the housing screws with a torque of 0.5 Nm.



7

7. Maintenance, Service

NOTE



The following must be observed when replacing the supply cable or heating cables after commissioning: the sealing used for the supply cable and/or the sealing(s) for the heating cable(s) and the insulating divider(s) affected must be replaced. The necessary spare parts are available as an optional service kit no. 05-0091-0203.

Replacing the sealing cable entry on the socket side/plug side

(PLEXO plug-in connector type 27-59P.-...)

NOTE



The insulation gel is applied with a brush. The sealings located in the sealing unit (supply cable, heating cable, heating cable splice) must be removed completely first and the inside must be cleaned. Apply a bead, at least 5 mm in diameter, of the insulating gel included in the scope of supply to the insides. Then distribute the grease evenly on the sealing area.



Once the sealing included in the scope of supply has been inserted into the connection or heating cable part, the sealing must be greased too. For this purpose two beads of the same size must be applied. These must be distributed evenly onto the sealing lips.

The quantity to be applied and also the manner of doing so is independent of the sealings located in the service kit and must always be done as described here therefore.

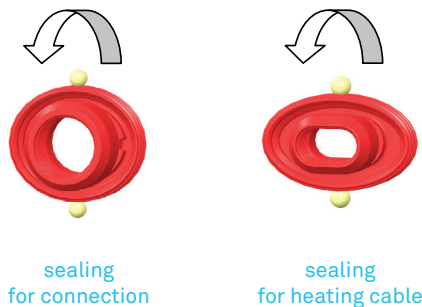

8. Commissioning



ATTENTION

Before commissioning, the acceptance test documentation must be drawn up as described in Chapter 9.

NOTE



- The PLEXO TCS heating system's serial number must be entered permanently with a suitable pen onto the "PLEXO TCS Heating system" marking areas (see Chapter 5.3).
- The commissioning of the heating system including the application of the serial number must be done either by an authorized person, a qualified specialist or an electrician. As the manufacturer, BARTEC can assign this responsibility to a third party.

9. PLEXO TCS Heating System Acceptance Test Documentation

9.1 General Points

As a supplement to the installation, the acceptance test report relative to the respective PLEXO TCS system must be created by the installer. With the aid of the (design) documentation the data relevant for explosion protection (e.g. parameters, temperature class, ambient temperature range etc.) is determined within the scope of the system possibilities and documented. This must be kept and made accessible for servicing purposes by the owner/managing operator throughout the entire service life of the heating circuit.

9.2 Heating System Acceptance Test PLEXO TCS

For claims under guarantee is essential to submit a correctly and fully completed acceptance report. The acceptance report can be found in the middle of this installation instruction.

10. Service address

BARTEC GmbH
 Max-Eyth-Str. 16
 97980 Bad Mergentheim
 Germany

Phone: +49 7931 597 0
 Fax: +49 7931 597 183
 info.bartec.com
 www.bartec.com

EU Konformitätserklärung
 EU Declaration of Conformity
 Déclaration UE de conformité
 № 21-1100-7C0001_C



Wir	We	Nous
-----	----	------

BARTEC GmbH
 Max-Eyth-Straße 16
 97980 Bad Mergentheim
 Germany

erklären in alleiniger Verantwortung, dass das Produkt Heizsystem PLEXO TCS	declare under our sole responsibility that the product Heating system PLEXO TCS	attestons sous notre seule responsabilité que le produit Système de chauffage PLEXO TCS
---	---	---

Typ 27-1100-**/******

auf das sich diese Erklärung bezieht den Anforderungen der folgenden Richtlinien (RL) entspricht ATEX-Richtlinie 2014/34/EU RoHS-Richtlinie 2011/65/EU und mit folgenden Normen oder normativen Dokumenten übereinstimmt	to which this declaration relates is in accordance with the provision of the following directives (D) ATEX-Directive 2014/34/EU RoHS-Directive 2011/65/EU and is in conformity with the following standards or other normative documents	se référant à cette attestation correspond aux dispositions des directives (D) suivantes Directive ATEX 2014/34/UE Directive RoHS 2011/65/UE et est conforme aux normes ou documents normatifs ci-dessous
--	--	---

EN IEC 60079-0:2018 **EN 60079-30-1:2017**
EN IEC 60079-7:2015 + A1 :2018 **EN 60079-31 :2014**

Verfahren der EU-Baumusterprüfung / Benannte Stelle	Procedure of EU-Type Examination / Notified Body	Procédure d'examen UE de type / Organisme Notifié
--	---	--

BVS 13 ATEX E 040 X

0158, DEKRA Testing and Certification GmbH, Dinnendahlstrasse 9, 44809 Bochum, DE



Bad Mergentheim, 17.12.2020

 i.V. Tobias Dold

Head of Business Unit EHT



i.V. Cristian Olareanu

Team Leader Certification Center

BARTEC

BARTEC GmbH
Max-Eyth-Str. 16
97980 Bad Mergentheim
Germany

Phone: +49 7931 597 0
Fax: +49 7931 597 494
info@bartec.com

bartec.com

Acceptance Test Report

to chapter 9.2

PLEXO TCS Heating System

Customer

PLEXO TCS plug-in connectors used

Type **27-59P** 
(from PLEXO plug-in connector; see also chapter 5.3)

Serial number **SN PLEXO:** _____
(from PLEXO plug-in connector; see also chapter 5.3)

Supply cable used
(only with PLEXO plug-in connector connection type 27-59P1-...)

Cable type (e. g. H05SS-F): _____
(from the project planning documents)

Core cross-section _____ mm²
(from the project planning documents)

Working temp. range (min/max) _____ (A) °C ≤ T ≤ _____ (B) °C
(from manufacturer's datasheet)

Heating cable used

Heating cable family (e. g HSB) _____
(from the project planning documents)

Selection number heating cable **07-58** 
(from the project planning documents)

Rated voltage AC 110 - 120 V AC 208 - 254 V

Temperature class **T** _____
(from the project planning documents)

Heat output _____ W/m
(from the project planning documents)

Fuse _____ A
(from the project planning documents)

Operating temp. range _____ (C) °C ≤ T ≤ _____ °C
(see chapter 5.1, column 7)

Supplier

Sheet of Comments/appendix

Date _____

Order no./Comm. no. _____

Project _____

Plant _____

PLEXO TCS heating system (please tick applicable box)

Heating system type no. **27-1100-** 
(from Chapter 5.1, column 10, depending on the heating cable used)

Heating system fuse rating _____ A
(from the project planning documents)

Connecting cable satisfies system requirement?
(Lower working temperature)
(only with PLEXO plug-in connector connection type 27-59P1-...)

YES NO
(A) ≤ T_a min from Chapter 5.1, column 8, depending on the heating cable used Lower ambient temperature heating system restricted by (A)

Supply cable satisfies system requirement?
(Upper working temperature)
(only with PLEXO plug-in connector connection type 27-59P1-...)

YES NO
(C) ≥ T min from Chapter 5.1, column 9, depending on the heating cable used Supply cable not suitable for this heating system

Ambient temperature _____ °C ≤ T_a ≤ _____ °C
(A) or (C), higher value applies; For lowest value; see chapter 5.1, column 8, depending on the heating cable used

Ex marking heating circuit

II 2 G Ex eb 60079-30-1 IIC _____ Gb
from Chapter 5.1, column 4, depending on the heating cable used

II 2 D Ex tb 60079-30-1 IIC _____ °C Db
from Chapter 5.1, column 5, depending on the heating cable used

Heating system serial no. _____
(to be assigned by installer)

NOTICE

 For claims under guarantee the submission of a correctly and completely written Acceptance Inspection Record is mandatory.

YES, acceptance test (report for documentation)

Place/date _____ Installer _____ Customer _____

Signature _____ Signature _____

BARTEC GmbH

Max-Eyth-Str. 16
 97980 Bad Mergentheim, Germany

Phone: +49 7931 597 0
 Fax: +49 7931 597 119

Mail: info@bartec.com
 Web: bartec.com