

## Manual Ex p Control Unit

APEX<sup>py</sup>



## Operating Instructions Safety Manual

### Ex p Control unit APEX<sup>py</sup>, Type 07-37A2-2111/\*520 Stainless steel version

ATEX / IECEx Zone 1 / 21

Document number: 01-37A2-7D0006

Revision: a

Order code: 452086



## 0 Table of contents

<b>0</b>	<b>Table of contents</b> .....	<b>3</b>
<b>1</b>	<b>About these operating instructions</b> .....	<b>7</b>
1.1	Highlighting in the document .....	8
1.1.1	Warnings .....	8
1.1.2	Symbols and icons .....	9
1.2	Technical changes.....	9
1.3	Languages.....	9
<b>2</b>	<b>Safety</b> .....	<b>10</b>
2.1	Intended use .....	10
2.1.1	Exclusive purpose .....	10
2.1.2	Improper use.....	10
2.2	Qualification of staff .....	10
2.3	Warranty .....	11
2.4	Safety instructions.....	12
2.4.1	General .....	12
2.4.2	Safety instructions for operation.....	12
2.5	Avoidance of damage to property .....	13
2.5.1	Short circuit due to improper connection .....	13
2.5.2	Triggering the safety function.....	13
2.5.3	EMC-compliant connection .....	13
2.5.4	Storage at an excessively high temperature .....	13
2.5.5	Aggressive cleaning agents .....	14
2.5.6	Danger to health due to improper disposal .....	14
2.6	Obligations of the owner.....	14
2.7	Instructions for use .....	14
2.8	Marking and test certificate .....	15
2.8.1	Ex p control unit APEX, type 07-37A2-2111/*520.....	15
2.9	Standards complied with .....	15
2.9.1	Ex p control unit APEX, type 07-37A2-2111/*520.....	15
2.10	SIL qualification / Safety according to IEC 61508 .....	16
2.10.1	SIL qualification .....	16
2.10.2	Safety function.....	17
2.10.3	Safety parameters.....	17
2.10.4	Reaction time .....	18
2.10.5	Residual risk .....	18

<b>3</b>	<b>Product description</b> .....	<b>19</b>
3.1	General information .....	19
3.2	Exp control units APEX .....	19
3.2.1	APEX design, type 07-37A2-2111/*520.....	20
3.3	Accessories .....	21
3.3.1	Valve fuse.....	21
3.3.2	Pressure monitor.....	21
3.3.3	Purge gas valve .....	21
3.3.4	p-operator panel .....	21
3.3.5	Programming switch .....	22
3.3.6	Programming cable .....	22
<b>4</b>	<b>Transport and storage</b> .....	<b>23</b>
4.1	Scope of delivery .....	23
4.2	Packaging.....	23
4.3	Transport .....	23
4.4	Storage .....	24
4.5	Disposal .....	24
<b>5</b>	<b>Installation</b> .....	<b>25</b>
5.1	Installation Exp control unit, type 07-37A2-2111/*520 .....	25
5.2	Installation of the pressure monitor .....	25
5.3	Assembly "Internal mounting kit, type 05-0091-0275" .....	26
5.4	Assembly "External mounting kit, type 05-0091-0280".....	27
5.5	Installation purging gas supply.....	28
5.5.1	Version G1/4" .....	29
5.5.2	Version G1/2" .....	30
5.5.3	Version G1/4" (Dust application).....	31
5.6	Pneumatic Connections .....	32
5.6.1	Pneumatic connections APEX, type 07-37A2-2111/*520 .....	32
5.7	Typical installations .....	32
5.7.1	Typical arrangement - outside installation / gas application .....	33
5.7.2	Typical arrangement - inside installation / gas application .....	34
5.7.3	Typical arrangement - outside installation / dust application.....	35
5.7.4	Typical arrangement - inside installation / dust application.....	36
<b>6</b>	<b>Electrical connections</b> .....	<b>37</b>
6.1	General .....	38
6.1.1	Connection notes .....	38
6.1.2	EMC-compliant connection .....	39
6.1.3	Pre-Fuse .....	40
6.1.4	Inductive loads.....	41
6.2	Electrical wiring APEX .....	42
6.2.1	"Ex e" connection terminals .....	43
6.2.2	Connection terminals "Ex i" .....	47

<b>7</b>	<b>Operation .....</b>	<b>53</b>
7.1	WEB interface .....	53
7.1.1	Adjusting the LAN connection .....	53
7.2	Operation of the WEB interface .....	55
7.3	Logging onto the WEB interface.....	55
7.4	Navigation in the WEB interface .....	55
7.5	Input of parameters.....	56
7.6	LED Indicators.....	56
7.7	Menu structure WEB-Interface.....	57
7.8	WEB-Interface operating menu .....	58
7.8.1	Purge parameter .....	58
7.8.2	Start page .....	61
7.8.3	Status .....	62
7.8.4	Messages.....	62
7.8.5	Parameter .....	62
7.8.6	Error log .....	63
7.8.7	Temperature sensors .....	63
7.8.8	Extended.....	65
7.8.9	Menu „Network“.....	69
7.8.10	Menu „Language“.....	69
7.9	System status .....	70
7.10	Reading container data .....	71
<b>8</b>	<b>Commissioning.....</b>	<b>72</b>
8.1	General .....	72
8.2	Sequence for the settings .....	72
8.3	Parameterization of purge gas valve.....	72
8.3.1	Setting for "Leakage air compensation" digital valves .....	73
8.4	Configuration for gas applications.....	73
8.4.1	Ex p settings – Manual purge .....	73
8.4.2	Ex p settings – Automatic purge.....	77
8.5	Configuration for dust applications .....	80
8.5.1	Ex p settings.....	80
<b>9</b>	<b>Functional test and procedure .....</b>	<b>82</b>
9.1	Safety during operation.....	82
9.2	Functional flow diagram for the Ex p control station .....	82
9.2.1	Ex p control flow chart.....	82
9.2.2	Functional flow diagram – dust.....	83

<b>10</b>	<b>Maintenance and care</b> .....	<b>84</b>
10.1	Types of purging gas.....	84
10.2	Maintenance work.....	84
10.2.1	Maintenance intervals.....	84
10.2.2	Visual inspection.....	85
10.2.3	Cleaning.....	85
10.2.4	Regular maintenance .....	85
10.3	Repairs.....	85
10.4	Faults and troubleshooting .....	85
10.4.1	Faults.....	86
10.4.2	Error messages .....	88
<b>11</b>	<b>Technical data</b> .....	<b>90</b>
<b>12</b>	<b>Order numbers</b> .....	<b>91</b>
12.1	Exp control unit APEX, standard .....	91
12.2	Pressure monitor module .....	91
12.3	Valve fuse.....	91
12.4	Purge gas valve .....	91
12.5	Operator panel .....	91
12.6	Installation accessories .....	91
12.7	Protective circuits .....	91
<b>13</b>	<b>Annex</b> .....	<b>92</b>
13.1	Purge diagram .....	92
13.2	Sequence diagram.....	93
13.3	Dimensions .....	94
13.3.1	Exp control unit APEX <sup>px</sup> , 07-37A2-2111/*520 .....	94
13.3.2	Pressure outlet, 17-51P3-1603.....	94
13.4	Software packages used .....	95
<b>14</b>	<b>Declaration of conformity</b> .....	<b>96</b>
14.1	Exp control unit APEX, Type 07-37A2-*1*1/**** .....	96

## 1 About these operating instructions



Please read carefully before putting the device into operation.  
Please observe the corresponding user manual.

This manual contains the information required for using the control unit in accordance with its intended purpose. It is addressed to technically qualified personnel.

Familiarity with and the technically perfect implementation of the safety instructions and warnings described in this manual are preconditions for safe installation and commissioning. The safety notes and warnings in these operating instructions are given in a general manner and only qualified personnel will have the necessary know how to interpret and implement them correctly in specific individual cases.

These operating instructions are an integral part of the scope of delivery even if, for logistical reasons, they can be ordered and delivered separately.

- ▶ Should you require further information, please request the required information from your local or responsible BARTEC branch. Read the operating instructions and in particular the safety instructions carefully before using the device.
- ▶ Keep the operating instructions during the entire service life of the device.
- ▶ Make the brief instructions accessible to all persons entrusted with handling the device.



## 1.1 Highlighting in the document

### 1.1.1 Warnings

Warnings are used in this user manual to warn of property damage and personal injury.

- ▶ Always read and follow these warnings.

Warnings are specially highlighted in this user manual and identified by symbols:

#### **DANGER**

**DANGER** indicates a hazardous situation which, if safety measures are not observed, may result in death or serious injuries with permanent damage.

#### **WARNING**

**WARNING** indicates a hazardous situation which, if safety measures are not observed, may result in serious injuries without permanent damage.

#### **CAUTION**

**CAUTION** indicates a hazardous situation which, if safety measures are not observed, can result in minor injuries.

#### **ATTENTION**

**ATTENTION** indicates a hazardous situation which, if the safety measures are not observed, may result in damage to property.

Explanation of the structure of a warning notice

#### **WARNING WORD**

**Identifies the source of danger, cause of danger or type of danger**

Consequence of non-compliance with the described safety measure.

- ▶ Safety measure

Example of a warning notice

#### **DANGER**

**Operation of the control unit in the case of damage!**

Death or serious injury.

- ▶ Put the control unit out of operation and secure it against restart.

## 1.1.2 Symbols and icons



Symbol	Explanation
	Important notices and information for the effective, efficient and environmentally friendly use of the product.
	Ex application; this symbol indicates special information for Ex applications
	Safety function, this symbolism indicates special notes for safe functions according to IEC 61508.

Table 1: Symbols and icons

## 1.2 Technical changes

The current versions of the datasheets, operating instructions, certificates and EC declarations of conformity as well as information on new accessories can be downloaded from [www.bartec.de](http://www.bartec.de) under “Products” in the product area “Control and Connection Equipment”, or requested directly from BARTEC GmbH.

## 1.3 Languages

The original user manual is written in German. All other available languages are translations of the original user manual.

The user manual is available in German and English. If further languages are required, these must be requested from BARTEC or stated when placing the order.

## 2 Safety

### 2.1 Intended use

#### 2.1.1 Exclusive purpose

The Ex p control unit APEX serves exclusively as a controlling and monitoring device for pressurized enclosures and is intended for use in explosion group II, category 2GD (EPL Gb and EPL Db) and temperature class T4 or T5 or for use in dusty environments with surface temperatures of T95 °C or T130 °C.

Furthermore, the safety function of the Ex p control unit satisfies the requirements on SIL 2 according to IEC 61508 and performance level “d” according to EN ISO 13849-1. The permissible operating data of the device used must be observed.

#### 2.1.2 Improper use

Any other use is not in accordance with the intended purpose and may lead to damage and accidents. The manufacturer will not be liable for any use beyond that of its intended purpose.

### 2.2 Qualification of staff

Target group	Skills
Design / engineering	<ul style="list-style-type: none"> <li>• Technical training</li> <li>• Knowledge and experience to identify and avoid hazards that may be caused by electricity</li> <li>• Understanding of the overall system</li> <li>• Configuration / programming</li> <li>• Special introduction for the Ex area</li> </ul>
Electrician / installer	<ul style="list-style-type: none"> <li>• Technical training</li> <li>• Knowledge and experience to identify and avoid hazards that may be caused by electricity</li> <li>• Understanding of the overall system</li> <li>• Special introduction for the Ex area</li> </ul>
Operator	<ul style="list-style-type: none"> <li>• Induction in operation by the owner</li> <li>• Special introduction for the Ex area</li> </ul>
Storage and transport companies	<ul style="list-style-type: none"> <li>• Loading and transport activities</li> <li>• Professional storage</li> </ul>

Table 2: Tasks of individual target groups

## 2.3 Warranty

### WARNING

#### UNAUTHORISED MODIFICATIONS AND/OR ALTERATIONS TO THE CONTROL SYSTEM.

Explosion protection as well as design and manufacture in line with strain and safety requirements are no longer guaranteed.

- ▶ Before making any modifications or alterations, contact the manufacturer to obtain written approval.
- ▶ Use only original spare parts and original wearing parts.



#### Assumption of warranty

The manufacturer assumes the complete warranty only and exclusively for the spare parts ordered from the manufacturer.

As a basic rule, our “General Terms, Conditions of Sale, and Delivery” apply. They are available to the managing operator on conclusion of contract at the latest. Warranty and liability claims for personal injury and damage to property are excluded if they are due to one or several of the following reasons:

- ➔ Improper use of the Ex p control unit.
- ➔ Incorrect installation, commissioning, operation and maintenance of the Ex p control unit.
- ➔ Non-compliance with the instructions in the manual with respect to transport, storage, assembly, commissioning, operation and maintenance.
- ➔ Unauthorized structural changes to the Ex p control unit.
- ➔ Inadequate monitoring of parts that are subject to wear.
- ➔ Improperly performed repairs.
- ➔ Disasters caused by foreign bodies and force majeure.

We guarantee the Ex p control unit and its accessories for a period of one year starting on the date of delivery from the Bad Mergentheim plant. This warranty covers all parts of the delivery and is restricted to the replacement free of charge or the repair of the defective parts in our Bad Mergentheim plant. Any packaging delivered here should be kept where possible. If necessary, the goods should be sent to us after written agreement. There is no entitlement to rectification at the site of installation.

## 2.4 Safety instructions

### 2.4.1 General

- ➔ Do not dry wipe or clean devices in hazardous areas!
- ➔ Do not open devices in hazardous areas.
- ➔ The general statutory regulations or guidelines relating to safety at work, accident prevention and environmental protection legislation must be observed, e.g. the German Industrial Health and Safety Ordinance (BetrSichV) or the applicable national ordinances.
- ➔ Wear suitable clothing and footwear in view of the risk of dangerous electrostatic charges.
- ➔ Avoid exposure to heat outside the specified temperature range (see Chapter “General technical data”).
- ➔ Avoid exposure to moisture.

### 2.4.2 Safety instructions for operation

#### Commissioning

- ➔ Before commissioning, check that all components and documents are available.

#### Inspection

- ➔ Under EN/IEC 60079-17 / ΓOCT IEC 60079-17-2013, the owner of electrical systems in hazardous areas is obliged to have them checked by a qualified electrician to ensure that they are in a proper condition.

#### Maintenance

- ➔ For electrical systems, the relevant installation and operating regulations must be observed (e.g. Directive 99/92/EC, Directive 2014/34/EU, BetrSichV or the nationally applicable ordinances EN/IEC 60079-14 / ΓOCT IEC 60079-14-2013 and the DIN VDE 0100, TR TS 012/2011 series)!
- ➔ Please observe the national waste disposal regulations for disposal.

#### Servicing

- ➔ Regular servicing is not necessary if the device is operated correctly in accordance with the installation instructions and ambient conditions.
- ➔ BARTEC recommends annual servicing and inspection.
- ➔ See Chapter “Maintenance and care”.

## Repairs

- ➔ Only authorized persons working in accordance with the latest development in technology and using original spare parts may do repairs on explosion-protected equipment. The applicable provisions must be observed.
- ➔ Repairs must be carried out in accordance with EN / IEC 60079-19 / ГОСТ 31610.19-2014.
- ➔ For SIL-qualified devices, only a corresponding electronics module with SIL qualification may be used.

All application settings must be re-entered. Therefore, you must conduct a restart after a repair. If you have saved the data of parameter assignment the first time you commissioned the Ex p control unit, you can transfer them back to the replacement control unit. Detailed information on the replacement of spare parts can be found in these operating instructions. After restart or transfer of the parameter assignment data, you must verify the parameters. Only then will the device be ready for operation again.

- ➔ For Ex applications, only one device and one electronic module may be used with corresponding Ex approval. Order the spare parts from your local representative. The serial number can be found on the type plate of the device, inside the enclosure.

## 2.5 Avoidance of damage to property

### 2.5.1 Short circuit due to improper connection

An incorrect connection of the power supply will destroy the electronics and void the warranty.

### 2.5.2 Triggering the safety function

Switching on again too quickly after switching off can cause internal voltage peaks in the power supply unit and thus trigger a safety function. After switching off the voltage path, wait at least 30 seconds before switching on again.

### 2.5.3 EMC-compliant connection

For the safe function of the Ex p control unit it is important to carry out the wiring in accordance with EMC. This includes observing the chapter Electrical connections with regard to EMC-compliant wiring and inductive loads.

### 2.5.4 Storage at an excessively high temperature

Store the Ex p control unit at the intended storage temperature since otherwise damage to the electronics or seals may occur. Ensure adequate air conditioning at high storage temperatures.

### 2.5.5 Aggressive cleaning agents

When selecting the correct cleaning agent, it is essential that it is suitable for use since otherwise damage may occur to seals and connections. Combustible products are generally not permitted.

### 2.5.6 Danger to health due to improper disposal

According to the European WEEE Directive, electrical and electronic equipment may not be disposed of with household waste. Their components must be sent separately for recycling or disposal because toxic and hazardous components can cause long-term damage to health and the environment if not disposed of properly.

As consumers, you are obliged under the Electrical and Electronic Equipment Act (ElektroG) to return electrical and electronic equipment at the end of its serviceable life free of charge to the manufacturer, the point of sale or to public collection points set up for this purpose. Details of this are regulated by the respective national law. The symbol on the product, the operating instructions or/and the packaging refers to these regulations. With this type of material separation, recycling and disposal of old devices, you make an important contribution to the protection of our environment.

## 2.6 Obligations of the owner

The owner undertakes to restrict permission to work with and on the APEX control unit to people who:

- ➔ are familiar with the basic regulations on safety and accident prevention and have been instructed in the use of the APEX control unit;
- ➔ have read and understood the documentation, the chapter on safety and the warnings.
- ➔ The owner must check that the safety regulations and accident prevention rules valid for the respective application are observed.

## 2.7 Instructions for use

- ➔ The overvoltage category II of the non-intrinsically safe circuits according to IEC 60664-1 must be observed.
- ➔ The warning “WARNING – DO NOT OPEN UNDER VOLTAGE” must be part of the external marking of the entire electrical device or the enclosure must have a locking system to prevent the fuses from being energized during replacement.

## 2.8 Marking and test certificate

The Ex p control unit is approved for the following areas.

### 2.8.1 Ex p control unit APEX, type 07-37A2-2111/\*520

ATEX (Europe)	
Marking	⊕ II 2(1)G Ex eb mb ib [ib pyb] [ia Ga] IIC T5/T4 Gb ⊕ II 2(1)D Ex tb [ib pyb] [ia Da] IIIC T130 °C / T95 °C Db
Test certificate	BVS 19 ATEX E 015 X
IECEX (International)	
Marking	Ex eb mb ib [ib pyb] [ia Ga] IIC T5/T4 Gb Ex tb [ib pyb] [ia Da] IIIC T130 °C / T95 °C Db
Test certificate	IECEX BVS 19.0038X
EAC (Eurasian Economic Union)	
Marking	1Ex e mb ib [ib py] [ia Ga] IIC T5 Gb X 1Ex e mb ib [ib py] [ia Ga] IIC T4 Gb X Ex tb [ib py] [ia Da] IIIC T95 °C Db X Ex tb [ib py] [ia Da] IIIC T130 °C Db X
Test certificate	EA3C RU C-DE.AЖ58.B.01809/21

## 2.9 Standards complied with

### 2.9.1 Ex p control unit APEX, type 07-37A2-2111/\*520

Standard	Designation
EN IEC 60079-0:2018/AC:2020 IEC 60079-0:2011 Edition: 6.0 ГОСТ 31610.0-2014	Explosive atmospheres – Part 0: General requirements
EN 60079-2:2014 IEC 60079-2:2007 Edition: 5.0 ГОСТ IEC 60079-2-2011	Explosive atmospheres - Part 2: Equipment protection by pressurised enclosure “p”
EN 60079-7:2015/A1:2018 IEC 60079-7:2006 Edition: 4.0 ГОСТ Р МЭК 60079-7-2012	Explosive atmospheres - Part 7: Equipment protection by increased safety “e”
EN 60079-11:2012 IEC 60079-11:2011 Edition: 6.0 ГОСТ 31610.11-2014	Explosive atmospheres - Part 11: Equipment protection by intrinsic safety “i”
EN 60079-18:2015/A1:2017 IEC 60079-18:2014 Edition: 4.0 ГОСТ Р МЭК 60079-18-2012	Explosive atmospheres - Part 18: Equipment protection by cast encapsulation “m”
EN 60079-31:2014 IEC 60079-31:2013 Edition: 2.0 ГОСТ IEC 60079-31-2013	Explosive atmospheres - Part 31: Equipment dust ignition protection by enclosure “t”
EN 61010-1:2010 IEC 61010-1:2010 Edition 3.0	Safety requirements for electrical equipment for measurement, control and laboratory use – Part 1: General requirements



Standard	Designation
EN 61000-6-4:2007 + A1:2011 IEC 61000-6-4:2018 Edition 3.0	Electromagnetic compatibility (EMC) – Part 6-4: Generic standards – Emission standard for industrial environments
EN 61000-3-2:2014 IEC 61000-3-2:2018 Edition 5.0	Electromagnetic compatibility (EMC) – Part 3-2: Limits – Limits for harmonic current emissions (equipment input current ≤ 16 A per phase)
EN 61000-3-3:2013 EN 61000-3-3:2013 + AMD1:2017 Edition 3.1	Electromagnetic compatibility (EMC) – Part 3-3: Limits – Limitations of voltage changes, voltage fluctuations and flicker in public low-voltage supply systems for equipment with rated current ≤ 16 A per phase, and not subject to conditional connection
EN 61326-1:2013 IEC 61326-1:2012	Electrical equipment for measurement, control and laboratory use – EMC requirements – Part 1: General requirements
EN ISO 13849-1:2015	Safety of machinery - Safety-related parts of control systems - Part 1: General principles for design
EN ISO 13849-2:2012	Safety of machinery - Safety-related parts of control systems - Part 2: Validation
DIN EN 62061:2016 IEC 62061:2015	Safety of machinery - Functional safety of safety-related of electrical, electronic and programmable electronic control systems

## 2.10 SIL qualification / Safety according to IEC 61508



The SIL qualification is only valid for the version of type 07-37A2-\*\*\*1/\*\*\*\* (APEX).



Important notes and information on the safe handling of the product.

### 2.10.1 SIL qualification

During the development of the Exp control unit, special attention is paid to the avoidance of systematic errors and the detection and control of random errors. The most important characteristics and requirements from the point of view of functional safety according to IEC 61508 are as follows:

- ➔ Internal monitoring of safety-relevant circuitry parts
- ➔ In the event of an error, transition of the safety-relevant outputs to a defined safe state
- ➔ Determination of the failure probability of the defined safety function
- ➔ Safe parameter assignment with non-safe operating environment
- ➔ Re-test

The SIL qualification of components is documented in this manual. All safety-relevant characteristic data required by the user and the planner for project planning and operation of the safety-instrumented system are summarized in this chapter. Further SIL-relevant information is integrated in this manual.

### 2.10.2 Safety function

The safety function of the Ex p control unit is the purging with a defined quantity of purging gas, the safe monitoring of the internal overpressure of the protected equipment and the release for operation. The safe state means that in the event of a drop in pressure or malfunction, the Ex p control unit switches to the safe state = deactivation of the protected equipment.

The “safe state” is triggered by:

- ➔ Falling below the minimum pressures within the Ex p equipment
- ➔ Illogical pressure values within the Ex p equipment
- ➔ Failure of the supply voltage

If the Ex p control unit does not deactivate or does not change to the safe state on request or in the case of an error, a hazardous failure exists.

### 2.10.3 Safety parameters

**THE FOLLOWING SAFETY PARAMETERS ARE WITHOUT OPTIONAL SENSORS.**



The optional sensors must be considered to determine the total failure rate!

- ▶ The safety parameters may be derived from the documentation on the optional sensors used.

Safety parameters according to IEC/EN 61508 / DIN EN ISO 13849-:

SIL = 2

Performance Level: = d

$PFH_{sys} = (PFH_{S+} + PFH_L + PFH_{FE} + PFH_C) = 1.70E-08$

HFT = 1

$SFF_{sys} = 92.85 \%$

MTTFd = 76 Yr

DC = 88.78 %

Device type B (complex equipment)

Interval of retests = 1 year

Category 3

### 2.10.4 Reaction time

The reaction time of the Exp control unit to safety-relevant functions without specific user delay times is smaller than 2 seconds.

With the Exp control unit it is possible to set a delay time for pressure fluctuations below the minimum pressure.

This results in a delay time of

$$T_{\text{Reaction}} = T_{\text{Control}} + T_{\text{Delay}}$$

$T_{\text{Reaction}}$  = Time required by the Exp control unit APEX to react to a safety-relevant function

$T_{\text{Control}}$  = Internal time required by the Exp control unit to recognise the safety-relevant triggering. < 2 seconds

$T_{\text{Delay}}$  = Adjustable delay time for safety-relevant triggering which is added to the reaction time  $T_{\text{Control}}$ .

### 2.10.5 Residual risk

Residual risks may arise from:

- ➔ Errors in project planning
- ➔ Errors in operating
- ➔ Errors in wiring

## 3 Product description

### 3.1 General information

The Ex p type of protection, referred to as “pressurized enclosure”, is based on the measure of purging out any explosive gases that are in a closed enclosure and then generating and maintaining a level of pressure that is higher than that of the ambient atmosphere. As the pressure inside the enclosure is higher as the atmospheric pressure, it is not possible at any time for explosive gases to penetrate the inside of the enclosure. This creates an Ex-free area in which electrical devices that are not themselves explosion-proof can be mounted and operated.

The APEX control units described in these operating instructions function on the principle of “pressurized enclosure with leakage loss compensation”. Specifically, this means that an overpressure in an enclosure is maintained by the addition of purging gas to compensate for the leakage losses from the enclosure.

To ensure that an explosive atmosphere that has penetrated during downtimes cannot become a hazard, the enclosure must be flushed with purging gas (compressed air or inert gas) before commissioning. The quantity depends on the inspection carried out during initial commissioning. The rate of flow is measured or determined at the outlet of the pressurized enclosure.

Since a safe state in the enclosure is only reached when the operation phase is started, it is necessary to use explosion-proof versions of the APEX control unit with its system components.

### 3.2 Ex p control units APEX



The control unit APEX with its system components is an automatic controller for monitoring, controlling and regulating pressurized enclosures in the hazardous areas of Zone 1 and Zone 21.

The control unit APEX is suitable for all standard applications for pressurized enclosures of Zone 1 and Zone 21.

The electrical installed parts inside the pressurized enclosure are enabled by the control unit APEX directly or by an additional switching device.

Once the control unit APEX, the purging gas valve and the pressure monitor have been mounted on the pressurized enclosure and after connection of mains voltage and purging gas, the pressurized system starts automatically.

The control unit APEX regulates the purging gas flow and the pressure inside the enclosure during the purging phase. When the operating phase is initiated, the APEX control unit automatically activates the zone 2/22 certified components mounted in the pressurized enclosure. The pressure inside the pressurized enclosure is maintained automatically during the operating phase and any leakage losses are compensated

### 3.2.1 APEX design, type 07-37A2-2111/\*520



The enclosure of variant two is available for the Ex p control unit APEX and is made of stainless steel.

In this enclosure variant, the associated pressure measurement card is integrated.

Ex p control units of this enclosure variant can be mounted internally or externally on the pressurized enclosure.

In terms of explosion protection, the enclosure provides Ex e protection for gas and Ex t protection for dust.

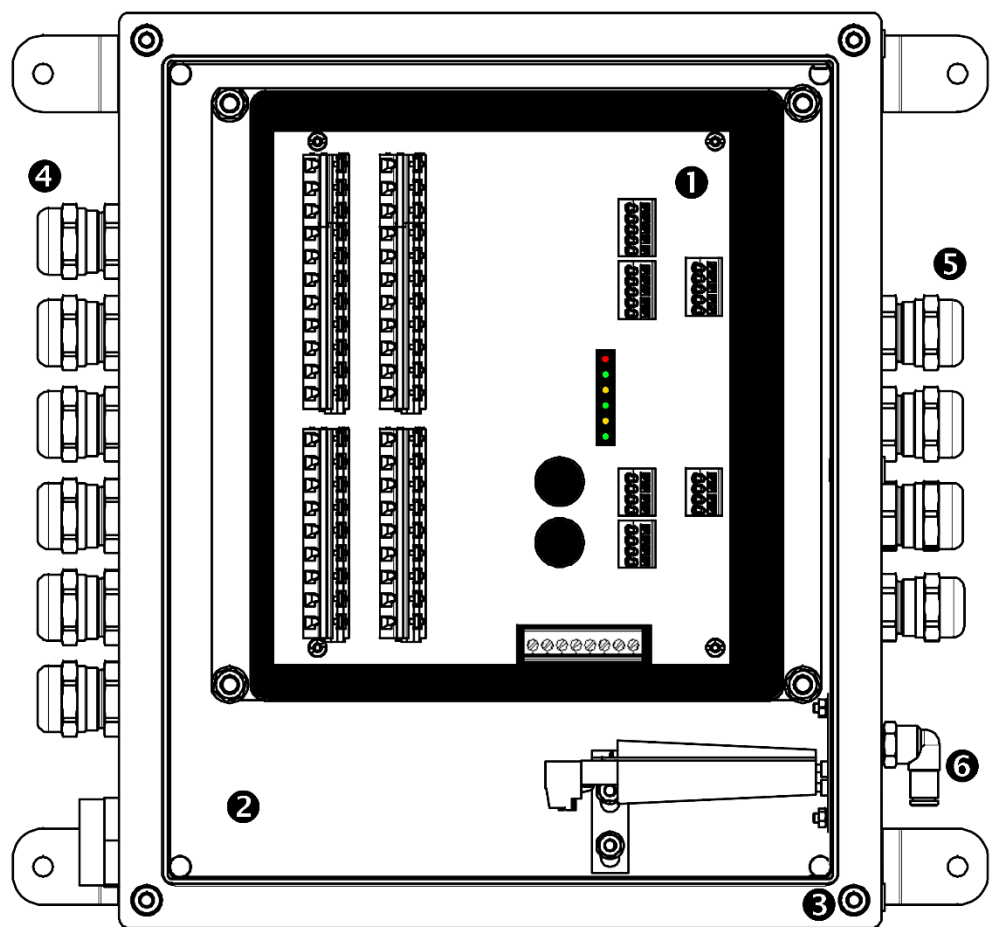

Item	Designation
①	Control electronics APEX
②	Protection enclosure
③	Outer earthing connection
④	Ex e cable entry
⑤	Ex i cable entry
⑥	Pressure measurement connections

### 3.3 Accessories

#### 3.3.1 Valve fuse

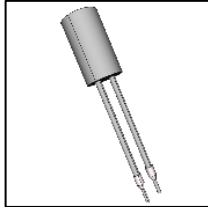

Valve fuse, type 05-0080-10\*\*

The valve fuse serves to secure the connected purging gas valve and is connected on the Ex e board of the control unit.

#### 3.3.2 Pressure monitor



Pressure monitor, Type 17-51P3-1\*03

The pressure monitor serves as overpressure valve and measuring unit for Ex pxb systems by means of the integrated orifice.

#### 3.3.3 Purge gas valve



Purge gas valve, Type 05-0056-\*\*\*\*

Different versions as digital purging gas valve (open/close) with integrated manual leakage air needle valve or proportional purging gas valve (regulating).

#### 3.3.4 p-operator panel



p-Operator Panel, Type 17-51P5-\*1111

The p-operator panel is a visualization unit for the control unit APEX or SILAS. It can be optionally connected and is used to display the system states and to parameterize the control units.

By means of mounting brackets, it can be used both as an add-on or in basic variant for installation.

It can be connected or disconnected during operation and it is therefore not necessary for it to be permanently connected to the control unit.

For the p-operator panel, the application is use is described in a separate operating manual.

### 3.3.5 Programming switch



The programming switch must be connected to the control unit in order to change parameters and switching values.

The control unit APEX does not accept values, which are changed without an active connected programming switch.

### 3.3.6 Programming cable

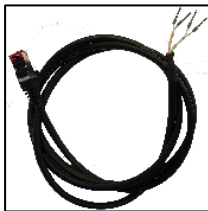

The programming cable is used to connect the Exp control unit to the PC. This must be connected to the control unit and PC in order to change parameters and switching values.

## 4 Transport and storage

### 4.1 Scope of delivery



Missing parts or damage must be reported immediately in writing to the forwarding agent, the insurance company or BARTEC GmbH.

Check the completeness of the scope of delivery using the delivery note.

As standard, each Exp control unit is delivered with the following scope of delivery:

- ➔ Parameterization cable LAN
- ➔ Parameterization switch
- ➔ Operating instructions

### 4.2 Packaging

The Exp control unit is delivered packed in film, on pallets and/or in boxes.

- ➔ Dispose of the packaging materials at the designated disposal points. Observe the applicable national regulations for disposal.

### 4.3 Transport



#### WARNING

**DEATH OR RISK OF INJURY FROM FALLING HEAVY SUSPENDED LOADS.**

- ▶ Never stand under suspended loads.
- ▶ Secure the Exp control unit before transport using suitable fastening (e.g. straps)

#### ATTENTION

**AVOID HARD IMPACTS, E.G. BY FALLING DOWN OR SETTING DOWN TOO VIGOROUSLY.**

The Exp control unit may be damaged.

- ▶ Only use hoists and load handling attachments with sufficient load bearing capacity.
- ▶ The permissible lifting weight of a lifting device may not be exceeded.
- ▶ Slowly set down the control unit.

Observe the weight of the goods to be transported and select an adequate transport device.



#### 4.4 Storage

Store the control unit in a horizontal position and at a temperature of -25 °C to +60 °C in its original packaging. The environment must be dry, dust-free and low vibration.

Store the control unit for a maximum of 2 years.

For warehouse logistics, we recommend the “first in – first out” principle.

#### 4.5 Disposal



Observe the applicable national regulations for disposal

Dispose of the control unit at the designated disposal points.

## 5 Installation

Before starting work, find out about the general safety instructions (see Chapter 2 Safety instructions).



Deviations in the installation of customer-specific assemblies may occur.

Observe the chapters Installation and Electrical connections.

Carry out the installation according to the following sections, unless otherwise agreed for customer-specific control units.

### 5.1 Installation Ex p control unit, type 07-37A2-2111/\*520



Attach the Ex p control unit to the intended position using the fastening lugs on the housing.

M6 screws with associated locking elements can be used as fastening material.

The corresponding hole pattern is available in the appendix.

### 5.2 Installation of the pressure monitor



Installation of the pressure monitor module for Zone 1 Type: 17-51P3-1603

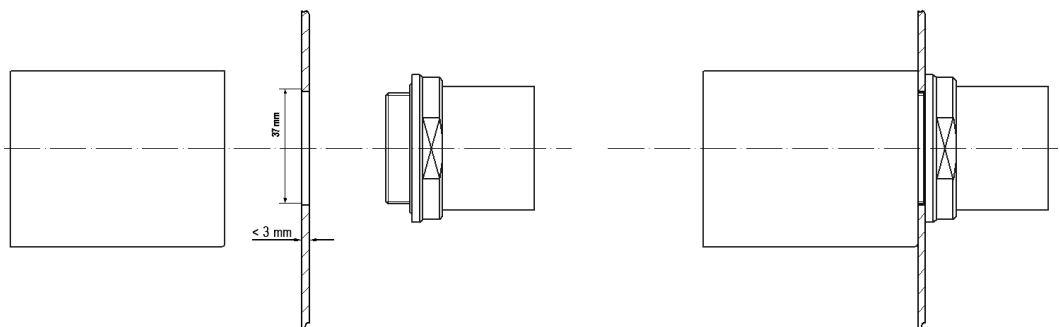

#### Procedure:

- ▶ A hole with a diameter of 37mm must be drilled into the wall of the pressurized enclosure.
- ▶ The air outlet with integrated flying spark barrier is inserted through the hole.
- ▶ The plastic body is screwed to the air outlet inside the pressurized enclosure.

### 5.3 Assembly "Internal mounting kit, type 05-0091-0275"

Mounting the atmosphere measuring point when mounting the Ex p control unit inside the protected equipment

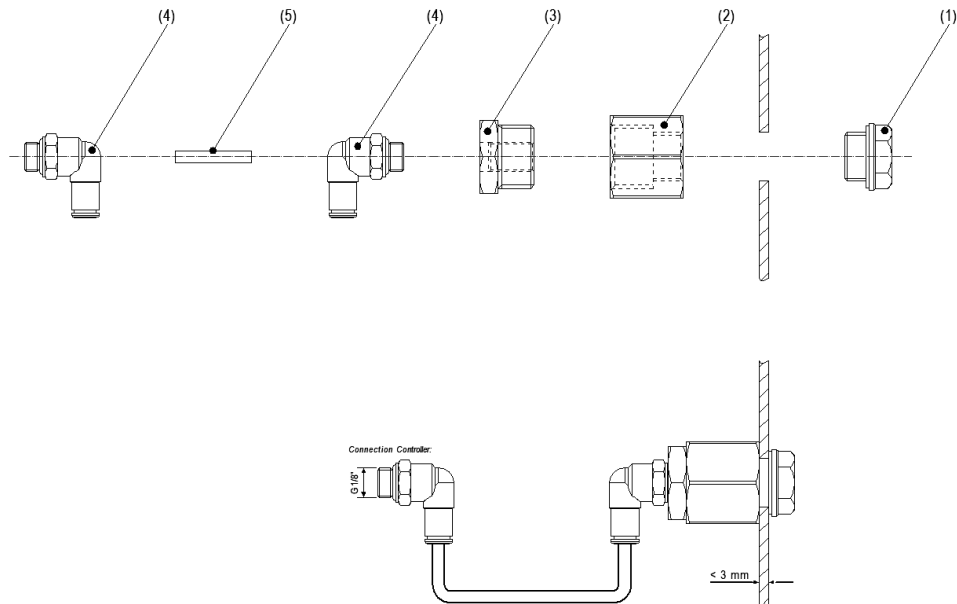

#### Procedure:

- ▶ Make a 16.5mm diameter bore hole at the intended location on the pressurized enclosure.
- ▶ Screw the bleed screw (1) together with the sleeve (2) in the bore hole.
- ▶ Screw the reduction (3) into the sleeve (2).
- ▶ Screw the hose connection (4) into the reduction (3).
- ▶ Push in the hose (5) into the hose connection (4) and lead it to the internally installed Ex p control unit.
- ▶ Replace the atmospheric measuring point by hose connection (4) and insert hose.

#### Schematic diagram:

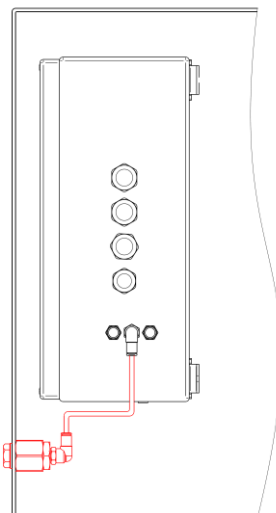

## 5.4 Assembly "External mounting kit, type 05-0091-0280"

For external mounting of the Ex p control unit, the two measuring points must be routed into the Ex p control cabinet using the "External" mounting kit.

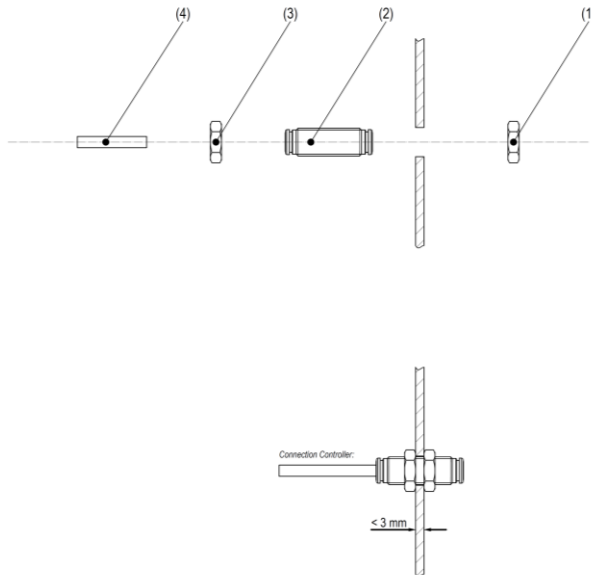

### Procedure:

- ▶ Drill two mounting holes  $d=10.5$  mm at the intended location of the pressurized equipment.
- ▶ Insert the tube bulkhead fitting pos. 2 into the hole.
- ▶ Fasten the bulkhead fitting in the center of the hole using the nuts (pos. 1 and 3).
- ▶ Insert the hose pos. 4 into the hose bulkhead fitting. The other end is plugged into the hose connection provided on the Ex p control unit.
- ▶ For the second borehole, proceed in the same way as for the first borehole.

### Schematic diagram:

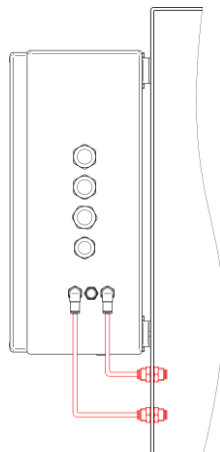

## 5.5 Installation purging gas supply

### ATTENTION

#### MATERIAL DAMAGE CAUSED BY THE ABSENCE OF A PURGE GAS NOZZLE.

Due to the build-up of internal pressure, there is a risk of excessive strain on the pressurized enclosure.

- ▶ Check if the purge gas nozzle is there.

#### NOT ENOUGH PURGING GAS DUE TO UNDERDIMENSIONED PURGING GAS SUPPLY LINE.



Pressurized enclosure does not go into operation due to low flow rate.

- ▶ Adjust the inner diameter of the purging gas supply line to the required flow rate.

The purge gas supply is composed of a pressure reducer, a purge gas valve and a purge gas nozzle. Depending on the capacity of the pressurized enclosure, the purge gas supply is available in the sizes G1/4" or G1/2".

The following table shows a guideline value in terms of protected volumes.

Capacity	Pre Pressure	Pressure reducer	Pressure outlet	Purge gas nozzle	Feeding pipe
< 50 liters	2 bar	¼"	18 mm	2.8 mm	10 mm
50 to 300 liters	2 bar	¼"	18 mm	3.9 mm	10 mm
300 to 700 liters	2 bar	¼"	18 mm	4.2 mm	15 mm
700 to 1000 liters	3 bar	½"	18 mm or 2x 18 mm	4.5 mm	15 mm
As of 1000 liters	3 bar	½"	2x 18 mm	5.5 mm	20 mm

(The levels specified in the table are reference values and can vary.)

The pressure reducer for lowering the pressure of the supplied purge gas is mounted on the outside of the pressurized enclosure. The purge gas valve, which releases the purge gas, is mounted inside the pressurized enclosure. The purge gas nozzle restricts the maximum flow of the purge gas and accordingly prevents pressure increasing to the maximum level inside the pressurized enclosure when a purge gas valve is defective.

The following shows the assembly of the purge gas supply. The required assembly material is included in the scope of supply.

### 5.5.1 Version G1/4"



The G1/4" purge gas supply is applicable up to a protected volume of 300 liters.

The assembly of the purging gas supply must be installed carefully. To ensure that the screwed parts are tight, they can be sealed by means of a Teflon® tape. Care must be taken to prevent the penetration of foreign particles during assembly.

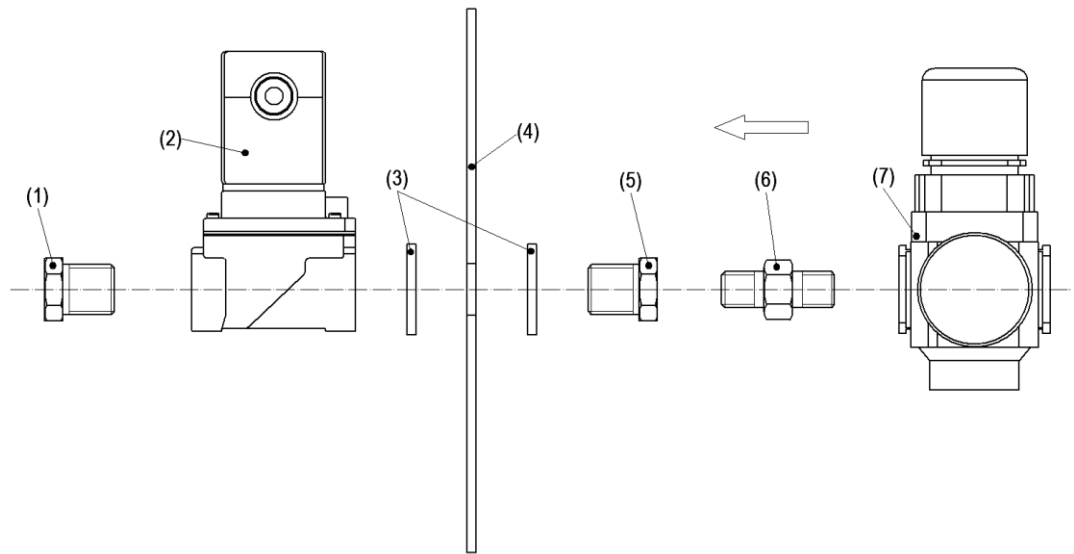

#### Procedure:

- ▶ Make a 17-mm-diameter borehole at the mounting position provided for that purpose in the pressurized enclosure (4).
- ▶ Mount the purge gas valve (2) onto the pressurized enclosure using the reducing sleeve (5) and the sealing washers (3).
- ▶ Screw in the purge gas nozzle (1) at the purge gas valve outlet (2).
- ▶ Screw the detachable double threaded nipple (6) into the reducing sleeve (5).
- ▶ Screw the G1/4" pressure reducer (7) onto the detachable double threaded nipple (6).

Item	Designation	Comment
(1)	Purge gas nozzle	Included in delivery (2)
(2)	Purge gas valve	
(3)	Sealing washers	Included in delivery (7)
(4)	Pressurized enclosure	
(5)	Reducing sleeve G 1/4"i / G3/8"a	Included in delivery (7)
(6)	Detachable double threaded nipple G1/4"	Included in delivery (7)
(7)	Pressure reducer G1/4"	Included in delivery (7)

## 5.5.2 Version G1/2"



The G1/2" purge gas supply version is applicable up to a protected volume of > 300 liters.

The assembly of the purging gas supply must be installed carefully. To ensure that the screwed parts are tight, they can be sealed by means of a Teflon® tape.

Care must be taken to prevent the penetration of foreign particles during assembly.

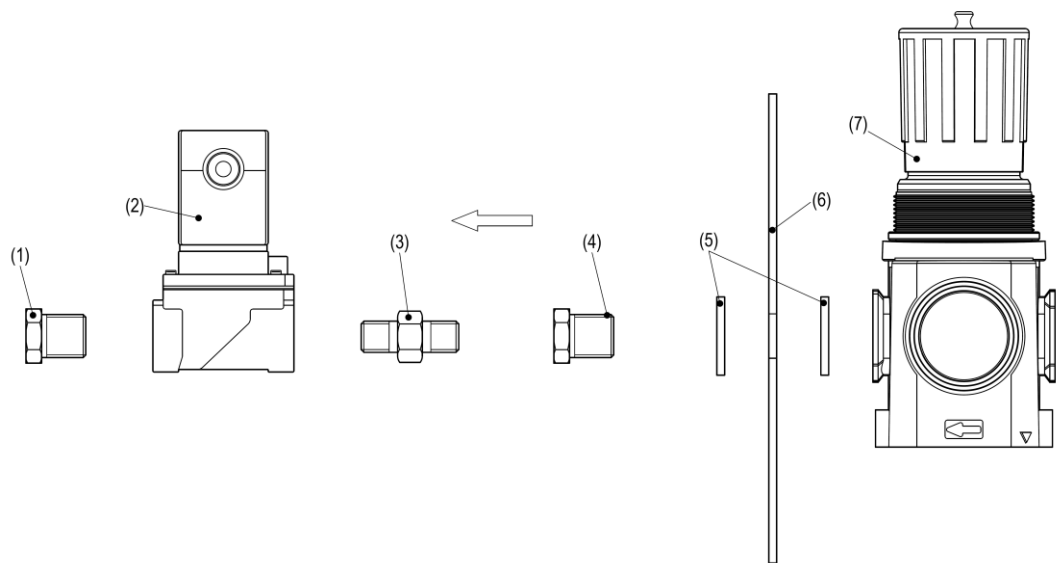
**Procedure:**

- ▶ Make a 21-mm-diameter borehole at the mounting position provided for that purpose in the pressurized enclosure (6).
- ▶ Mount the G1/2" pressure reducer (7) onto the pressurized enclosure using the reducing sleeve (4) and the sealing washers (5).
- ▶ Screw the detachable double threaded nipple (3) into the reducing sleeve (4).
- ▶ Screw the purge gas valve (2) onto the detachable double threaded nipple (3).
- ▶ Screw in the purge gas nozzle (1) at the purge gas valve outlet (2).

Item	Designation	Comment
(1)	Purge gas nozzle	Included in delivery (2)
(2)	Purge gas valve	
(3)	Detachable double threaded nipple G3/8"	Included in delivery (7)
(4)	Reducing sleeve G3/8"i / G1/2"o	Included in delivery (7)
(5)	Sealing washer	Included in delivery (7)
(6)	Pressurized enclosure	
(7)	Pressure reducer G1/2"	

### 5.5.3 Version G1/4" (Dust application)



For dust applications, there is no purge phase in a pressurized enclosure and only positive overpressure is applied. Therefore, no purge gas valve is present.

The assembly of the purging gas supply must be installed carefully. To ensure that the screwed parts are tight, they can be sealed by means of a Teflon® tape. Care must be taken to prevent the penetration of foreign particles during assembly.

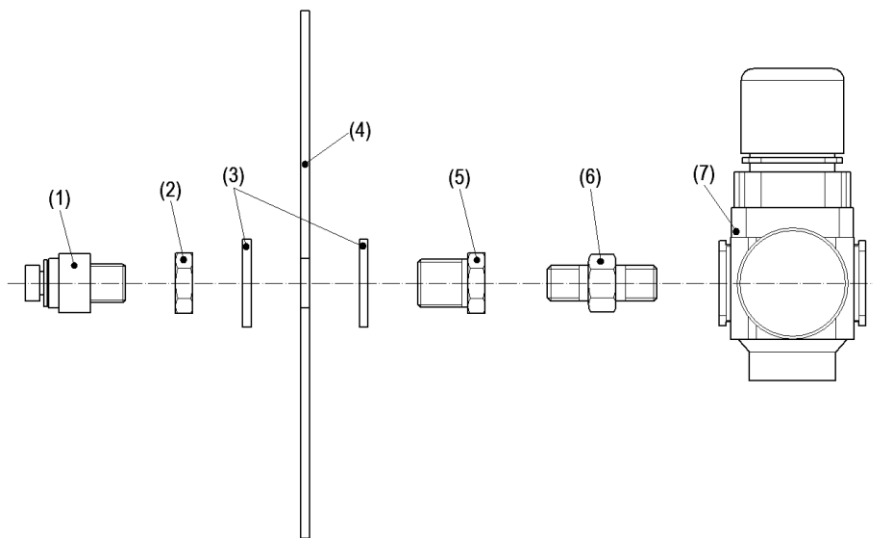

#### Procedure:

- ▶ Make a 17-mm-diameter borehole at the mounting position provided for that purpose in the pressurized enclosure (4).
- ▶ Mount the reducing sleeve (5) with sealing washers (3) using the G3/8" nut (2) in the pressurized enclosure.
- ▶ Screw in the adjustable purge gas nozzle (1) into the reducing sleeve (5) inside the pressurized enclosure (4).
- ▶ Screw the detachable double threaded nipple (6) into the reducing sleeve (5).
- ▶ Screw the G1/4" pressure reducer (7) onto the detachable double threaded nipple (6).

Item	Designation	Comment
(1)	Adjustable purge gas nozzle	
(2)	G3/8" nut	
(3)	Sealing washer	Included in delivery (7)
(4)	Pressurized enclosure	
(5)	Reducing sleeve G 1/4"i / G3/8"a	Included in delivery (7)
(6)	Detachable double threaded nipple G1/4"	Included in delivery (7)
(7)	Pressure reducer G1/4"	



## 5.6 Pneumatic Connections

### 5.6.1 Pneumatic connections APEX, type 07-37A2-2111/\*520

Installation inside Ex p equipment



When installing the controller inside the pressurized equipment, the atmospheric connection must be routed to the outside. Please use the assembly kit for the atmospheric connection here.

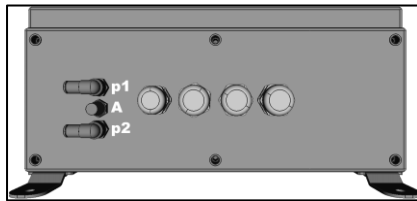

The adaption pressure measurement card comes with two quick hose connections as standard. Hose outer diameter 4mm.

Connection	Description
p1	Internal pressure
A	Atmosphere
p2	Internal pressure, redundant

## 5.7 Typical installations

### DANGER

#### INCORRECT ARRANGEMENT OF THE SYSTEM COMPONENTS ON THE EX P OPERATING EQUIPMENT

The installation specifications from IEC / EN 60079-2 must be observed. Light or heavy explosive gases must be observed.

- ▶ Check arrangement

### 5.7.1 Typical arrangement - outside installation / gas application

The following figures show the installation of the APEX<sup>px</sup> control unit with one or two pressure outlet modules. The Ex p control unit is mounted outside the Ex p equipment.

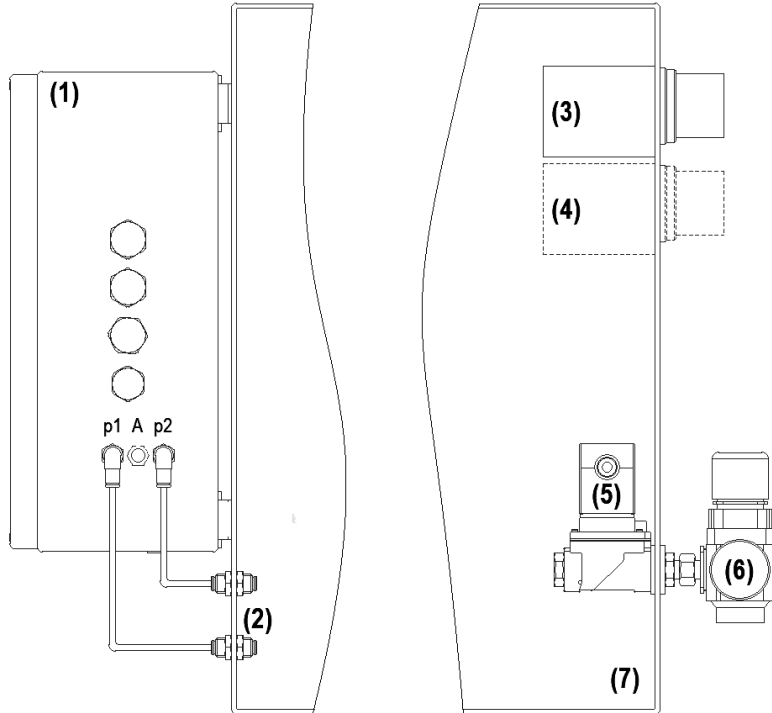

Position	Description
(1)	Ex p Controller
(2)	Mounting kit "External"
(3)	First pressure outlet
(4)	Optional second pressure outlet from volume > 700 liters
(5)	Purge gas valve with purge gas nozzle
(6)	Pressure reducer
(7)	Ex p protected equipment

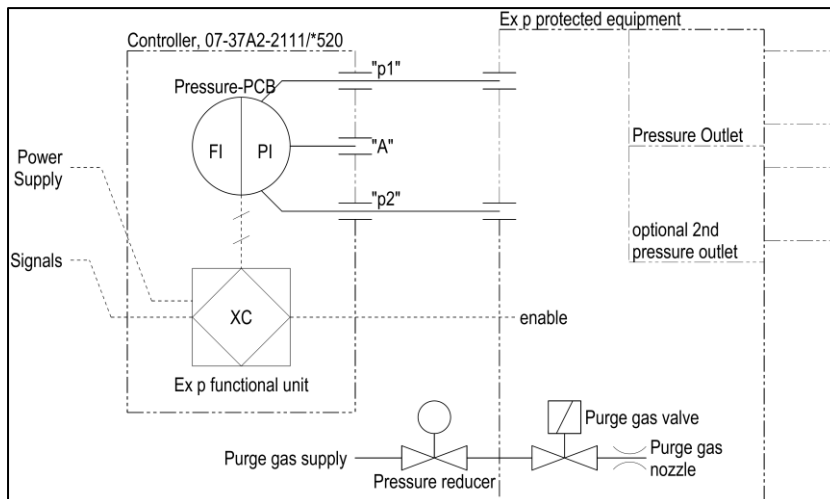

### 5.7.2 Typical arrangement - inside installation / gas application

The following figures show the mounting of the APEXpx control unit with one or two pressure monitor outputs. The Ex p control unit is mounted inside the Ex p equipment.

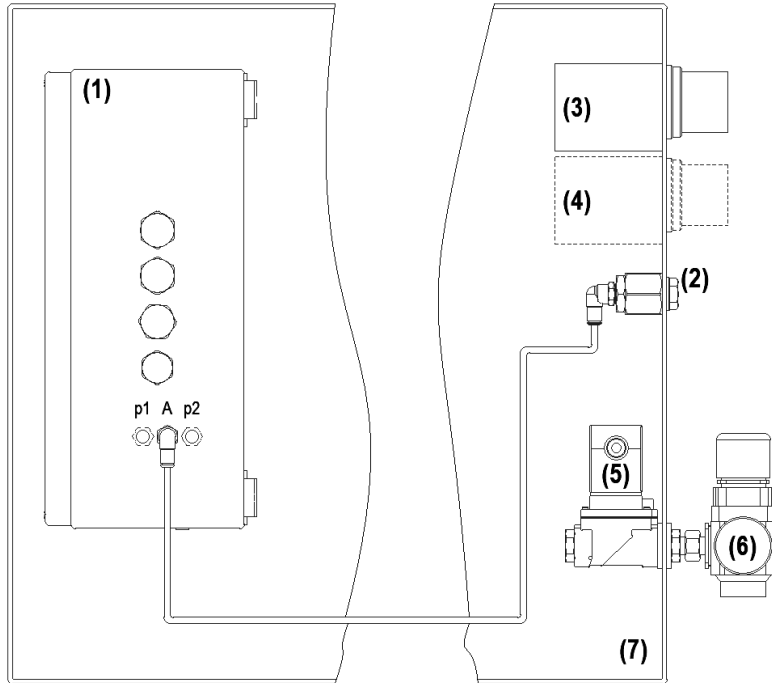

Position	Description
----------	-------------

- (1) Ex p Controller
- (2) Mounting kit "Internal"
- (3) First pressure outlet
- (4) Optional second pressure outlet from volume > 700 liters
- (5) Purge gas valve with purge gas nozzle
- (6) Pressure reducer
- (7) Ex p protected equipment

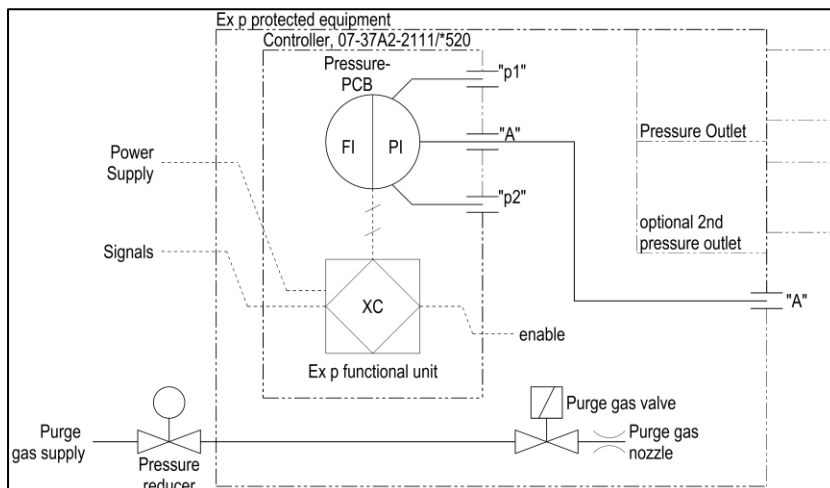

### 5.7.3 Typical arrangement - outside installation / dust application

The following figures show the installation of the APEX<sup>px</sup> control unit with one or two pressure outlet modules. The Ex p control unit is mounted outside the Ex p equipment.

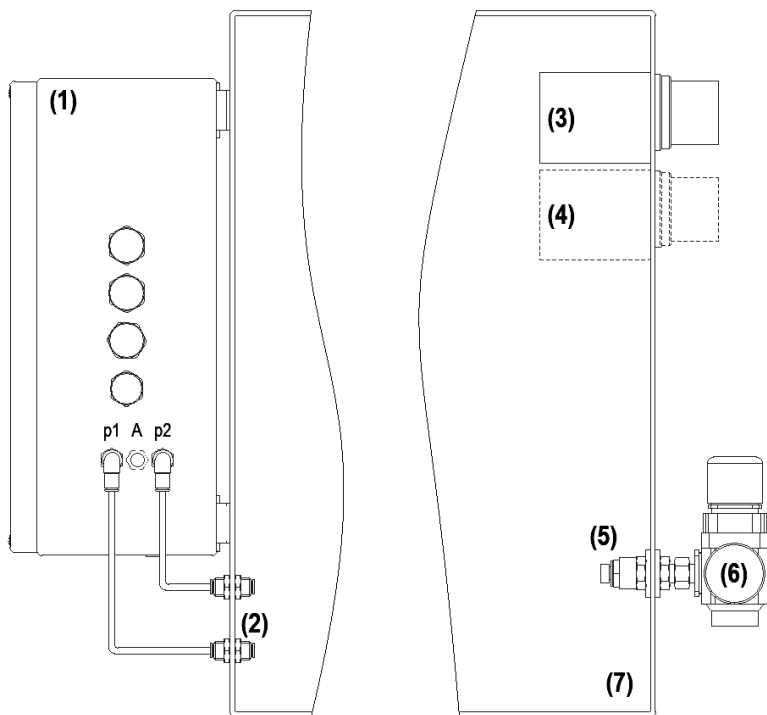

Position	Description
(1)	Ex p Controller
(2)	Mounting kit "External"
(3)	First pressure outlet
(4)	Optional second pressure outlet from volume > 700 liters
(5)	Adjustable purge gas nozzle
(6)	Pressure reducer
(7)	Ex p protected equipment

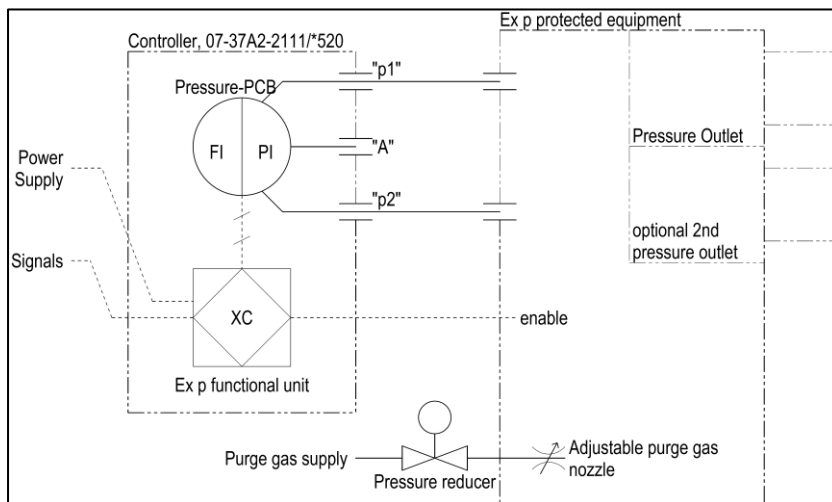

### 5.7.4 Typical arrangement - inside installation / dust application

The following figures show the mounting of the APEXpx control unit with one or two pressure monitor outputs. The Ex p control unit is mounted inside the Ex p equipment.

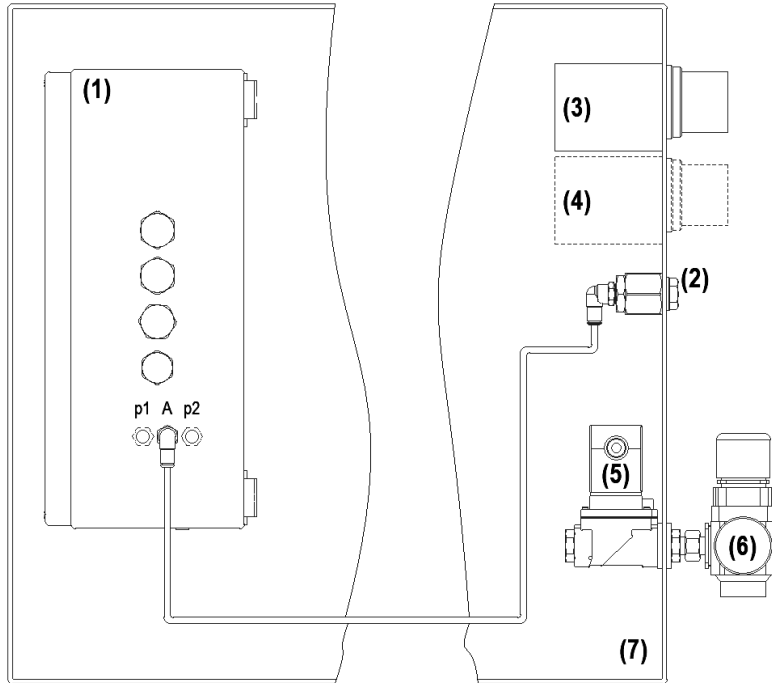

Position	Description
(1)	Ex p Controller
(2)	Mounting kit "Internal"
(3)	First pressure outlet
(4)	Optional second pressure outlet from volume > 700 liters
(5)	Adjustable purge gas nozzle
(6)	Pressure reducer
(7)	Ex p protected equipment

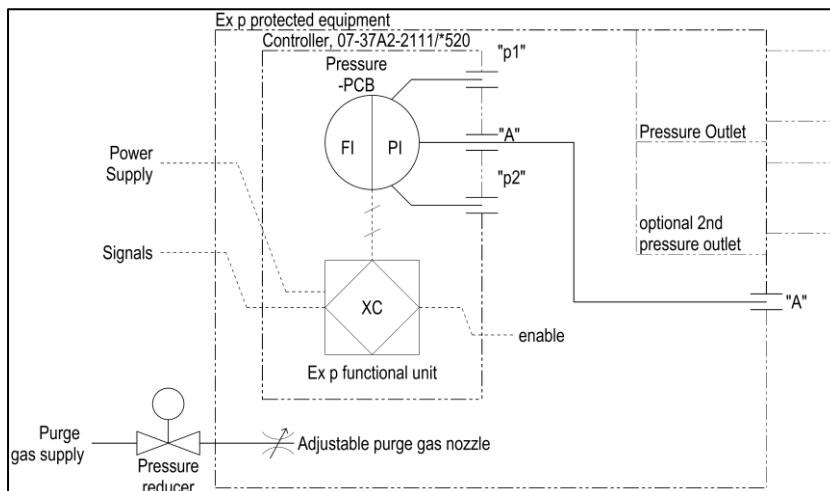

## 6 Electrical connections

### **⚠ DANGER**

**DEATH OR SERIOUS PHYSICAL INJURY DUE TO WORK ON LIVE PARTS.**

Fatal injury from electrical current.

- ▶ Observe the five safety rules for work on electrical systems: Disconnect mains; protect against unintended reconnection; verify the absence of voltage; earth and short-circuit; cover or safeguard nearby live parts.

Connection terminals with the type of protection “Ex e” or “Ex i” are on the connection board of the Ex p control unit.

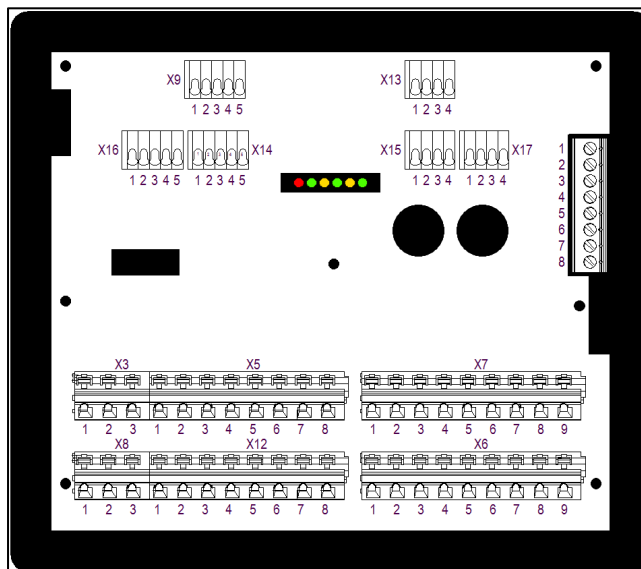

	Terminal row	Function
Ex e	X3	Power supply
	X5	2x signal relay, 1x CO each
	X8	Enable, with voltage
	X12	Indicator relay, 4x NO
	X7	Purging gas valve, empty contacts
	X8	Purging gas outlet, LAN
	X9	Bypass, temperature sensor 1
Ex i	X16	Parameter enable, temperature sensor 2
	X14	Main switch, temperature sensor 3
	X13	opt. sensor 1 [ia]
	X15	opt. sensor 2 [ib]
	X17	p-operator panel
	Measurement card	Pressure measurement card

## 6.1 General

### 6.1.1 Connection notes

#### DANGER

**DEATH OR SERIOUS PHYSICAL INJURY WHEN THE COVER OF THE CONTROL UNIT APEX IS OPENED IN AN EXPLOSIVE ATMOSPHERE.**

Risk of explosion.

- ▶ Before opening the lid of the enclosure, check the atmosphere for any explosive gases.

#### ATTENTION

**SHORT-CIRCUITS DUE TO LOOSE OR PROTRUDING WIRES IN THE CONTROL UNIT APEX.**

The control unit APEX may be damaged.

- ▶ All core wires, including those not required, must be attached to a terminal.
- ▶ Lay the wires only in the space between the shield bus and the connecting terminal.
- ▶ Make sure that none of the wires are loose or jump out/protrude.

**AVOID DAMAGE TO THE SEAL.**

Cancellation of the Ex protection concept.

- ▶ Visual inspection of the seal when closing the control unit APEX (cleanliness, seat and integrity).

**AVOID RAPID DISCONNECTION AND RECONNECTION OF THE POWER SUPPLY.**

Internal protection circuits can trip

- ▶ Wait approx. 30 seconds between switching off and switching on again.



Recommendation for the securing of active parts

The Ex e terminals should be protected against contact by a protective cover.

The procedure for connecting cables to the Ex p control unit is described in the following:

**Procedure:**

- ▶ Establish the electrical connections in accordance with the terminal assignment. Terminals are designed in tension spring technology. A suitable tool must be used for this purpose.

## 6.1.2 EMC-compliant connection



The manufacturer (EMC-compliant design of a system) and the user (interference-resistant construction of a complete system) must ensure the electromagnetic compatibility of a complete system in accordance with the EMC Directive.

BARTEC Ex p control units can only operate safely and trouble free with an EMC-compliant wiring. This chapter supports you in the EMC-compliant design of your system.

During operation of an electronic or electrical device, interactions occur with other neighbouring devices. The neighbouring devices act as a source of interference, affecting the other device as a susceptible device.

BARTEC Ex p control units are considered to be electromagnetically compatible and have been developed in compliance with the applicable EMC standards and limits.

A large part of the safe operation of the Ex p control unit under EMC influences is ensured by professional, clean line connections.

### 6.1.2.1 Cables and connections

Please observe the following points:

- ▶ Divide the cables into groups.
    - ➔ Power cables (power lines, power supply)
    - ➔ Signal cables, shielded, min 0.5 mm<sup>2</sup>
    - ➔ Data cables, shielded.
  - ▶ Ensure that the wiring is correct. Ensure that over couplings between signal/data cables and power cables is avoided.
  - ▶ Signal cables and power cables may only cross at right angles.
  - ▶ Route signal and data cables as closely as possible to ground surfaces.
  - ▶ Unused wires in signal and data cables should be short-circuited and earthed (additional shielding effect).
  - ▶ Where possible, lay signal cables only on one level in the device and insert them only from one side into the device.
  - ▶ Avoid the formation of current loops.
  - ▶ Ensure that unshielded cables within a circuit (outgoing and return conductors) are twisted in pairs as far as possible.
  - ▶ Where possible, lay short cables. This avoids coupling capacities and inductances.
  - ▶ Do not lay cables and wires freely in the device but run them as tightly as possible along the enclosure wall or earthed mounting surfaces.
- Use ferrite cores for the inserted cables.

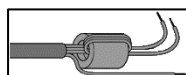

The individual conductors must be looped through the ferrite core here.



### 6.1.2.2 Earthing cables

The earthing of a system satisfies protective and functional measures.

Please observe the following points:

- ▶ Earthing cables should be as short as possible.
- ▶ Avoid ground loops.
- ▶ Use ground straps with a width of at least 10 mm.

### 6.1.2.3 Shielding

In order to ensure trouble free operation of a system, cables with the largest possible surface area (not cross section) are important. High frequency currents do not flow through the entire cross section of the conductor, but predominantly on the outer skin of a conductor.

Please observe the following points:

- ▶ Always connect the shield over a large area using metal cable clips.
- ▶ Avoid placing the shield on the ground with long wires.

### 6.1.3 Pre-Fuse

#### ATTENTION

**NOTE THE RATED CURRENT OF THE RELEASE CIRCUIT (K1) AND ADD IT TO THE FOLLOWING VALUES. THE FOLLOWING VALUES ARE ONLY FOR THE EX P CONTROL DEVICE.**

If the dimensions are too small, the Ex p control unit may be destroyed.

- ▶ Rated current (controller) + rated current release circuit (K1).

Variant	APEX, DC	APEX, AC
Rated current control unit	$\geq 3,15$ A	$\geq 2$ A
Rated voltage control unit	$\geq 63$ V DC	$\geq 277$ V AC
Response time	Time lag	Time lag
Switch-off current	$\geq 1,5$ kA	$\geq 1,5$ kA
Melt integral	12... 34 A <sup>2</sup> s	9,7... 14,7 A <sup>2</sup> s

### 6.1.4 Inductive loads

#### ATTENTION

#### INTERFERENCE FROM INDUCTIVE LOADS CAN DESTROY THE EXP CONTROL UNIT.

Over voltages occur when switching off inductive loads (e.g. contactor coils). Voltage peaks of up to 4 kV can occur with a voltage slope of 1 kV / microsecond.

- ▶ Interference suppression of AC-fed inductive loads by means of a varistor.
- ▶ Suppressing DC-fed inductive loads by means of a freewheeling diode.

For inductive loads, use protective circuits to limit the voltage peaks that occur during switch-off.

The consequences of this can be:

- Coupling of interference signals that generate false signals
- Destroy the Ex p control unit.

Protective circuits protect the Ex p control unit from premature failure due to the overvoltage that occurs when the current flowing through an inductive load is interrupted. In addition, protective circuits limit the electrical disturbances that occur when switching inductive loads.

#### 6.1.4.1 Protective circuit for AC supplied inductive loads

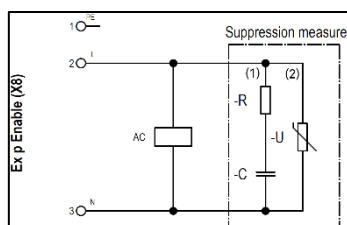

This circuit variant is used for inductive loads AC voltage fed relays / contactors. In this circuit variant, the property of the VDR resistor is exploited to become low-resistance above a certain threshold voltage. This short-circuits the self-induction voltage.

Any oscillation that arises is damped by the RC snubber.

Interference suppression measure, e.g. BARTEC 07-7311-93GU/K000

RC snubber

Varistor

#### 6.1.4.2 Protective circuit for DC supplied inductive loads

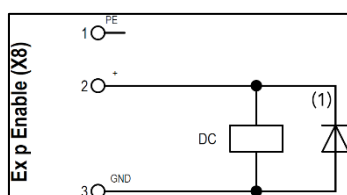

This circuit variant is used for DC-powered relays / contactors. A diode is connected in reverse direction parallel to the coil.

Interference suppression measure, e.g. BARTEC 07-7311-61GF/5400

Free-wheeling diode

## 6.2 Electrical wiring APEX

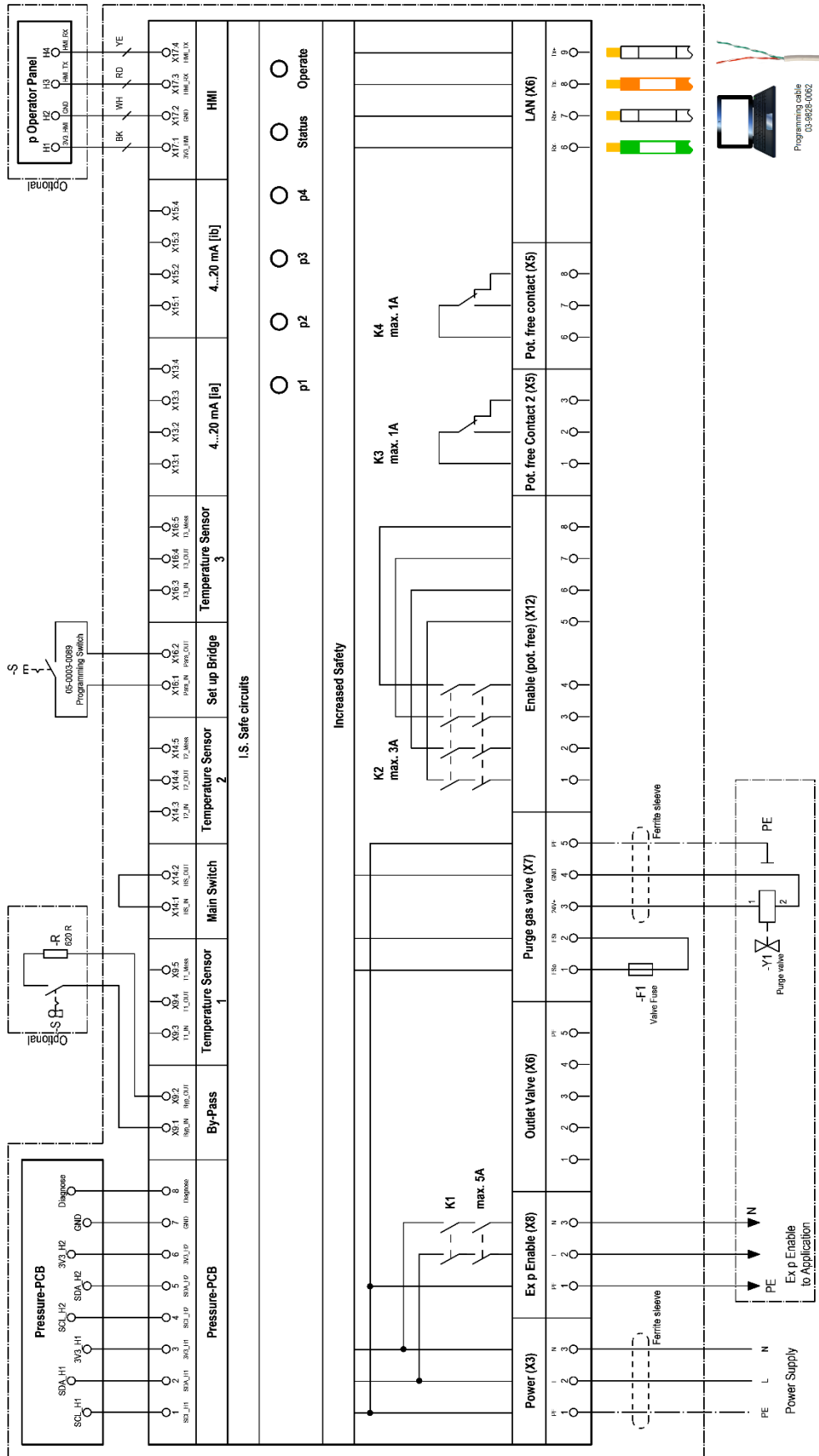

## 6.2.1 “Ex e” connection terminals

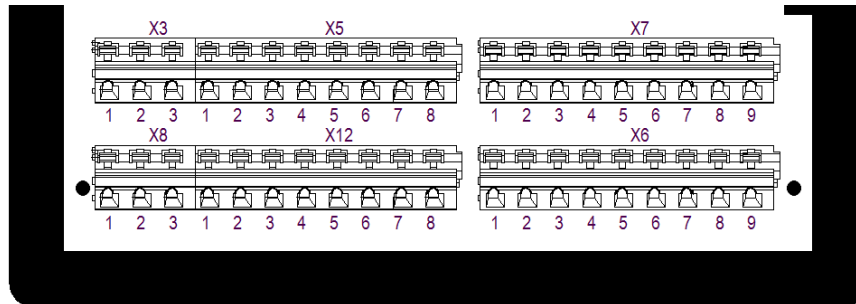

### 6.2.1.1 Terminal row “X3”

#### ATTENTION

#### MATERIAL DAMAGE DUE TO INCORRECT SUPPLY VOLTAGE.

Internal electronics of the Ex p control unit can be destroyed.

- ▶ Before activating the supply voltage, compare the value of the supply voltage with the printed value of the control unit.

#### Active protective measure.

- ▶ As an active protective measure, the supply voltage is protected by a fuse (min 1500 A breaking capacity) and an FI current circuit breaker.

#### EMC compliant wiring

Internal electronics can be disturbed by missing EMC measures and cause unforeseen shutdowns.

- ▶ Loop the supplied ferrite sleeve into the power supply.
- ▶ See EMC-compliant wiring

An der Klemmreihe X3 wird die Versorgungsspannung angeschlossen.

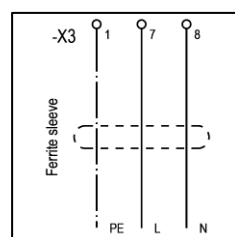

#### ▲ Mounting ferrite sleeve

Procedure:

- ▶ Loop the conductors "L" and "N" once through the ferrite sleeve.
- ▶ Connect the "L" and "N" conductors to the terminals provided

Terminal	Connection	Function
1	PE	PE power supply
2	L (+)	Phase (+ conductor) power supply
3	N (-)	Neutral (GND) power supply

## 6.2.1.2 Terminal row "X5"

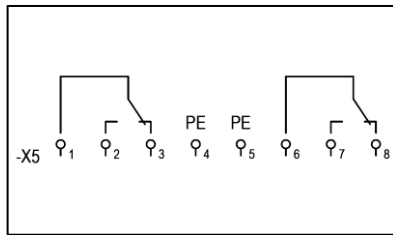

The Ex p control unit has one floating changeover contact K3 and one floating changeover contact K4 for signaling and processing signals. The associated switching function can be set in the Ex p control unit via the WEB interface and is freely programmable. The maximum switching current is 1 A.

Terminal	Connection	Function
1	K3 – COM	Common contact
2	K3 – NO	Normally open contact
3	K3 – NC	Normally closed contact
4 / 5	PE	
6	K4 – COM	Common contact
7	K4 – NO	Normally open contact
8	K4 – NC	Normally closed contact

## 6.2.1.3 Terminal row "X8"

**ATTENTION****MATERIAL DAMAGE DUE TO OVERCURRENT IN THE CONTROL ELECTRONICS.**

Welding of the enabling relays or destruction of the electronics by inductive loads.

- ▶ The Ex p enable (Relay K1, X8 terminal 2 and 3) can only be operated in conjunction with a mains fuse (max 5 A, 1,500 A switching capacity, fast).
- ▶ Supplement inductive loads with suitable interference suppression measures. See chapter 6.1.4.

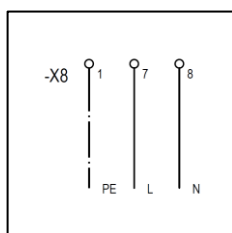

The supply voltage is connected to terminal row X8.

The application within the pressurized enclosure is enabled by the Ex p control unit. There may be no voltage in the pressurized enclosure when the Ex p control unit is deactivated.

The Ex p enable can switch a maximum of one circuit of one phase with neutral conductor and can be loaded with a maximum of 5 A. If the current load within the pressurized enclosure has more than 5 A or more than one phase, this must be implemented with a separately certified Ex d pre-conductor which is controlled by the Ex p control unit.

Terminal	Connection	Function
1	PE	PE power supply
2	L' (+)	Enable phase Ex p device
3	N' (-)	Enable neutral Ex p device

### 6.2.1.4 Terminal row “X12”



Floating signaling K2 can be classified as pure enable according to SIL when used.

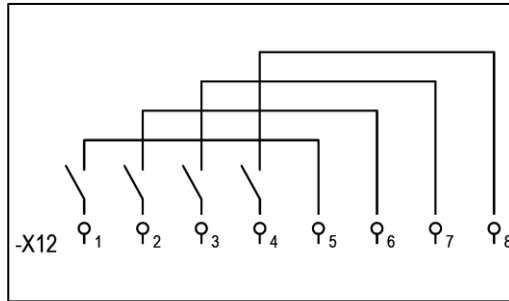

A floating signal (4x NO) is available on the Exp control unit. This signal can either be used as an enable that is also safety related.

Or it can be used as a floating signal.

Terminal	Connection	Function
1	K2_1 - NO	Normally open contact
2	K2_2 - NO	Normally open contact
3	K2_3 - NO	Normally open contact
4	K2_4 - NO	Normally open contact
5	K2_1' - NO	Normally open contact
6	K2_2' - NO	Normally open contact
7	K2_3' - NO	Normally open contact
8	K2_4' - NO	Normally open contact

### 6.2.1.5 Terminal row “X7”

#### ATTENTION

#### MATERIAL DAMAGE DUE TO INCORRECT PRE-FUSING.

Valve or Exp control unit may be damaged.

- ▶ Operate the digital purge gas valve only with a 1.0 A pre-fuse and the proportional purge gas valve only with a 1.6 A pre-fuse.

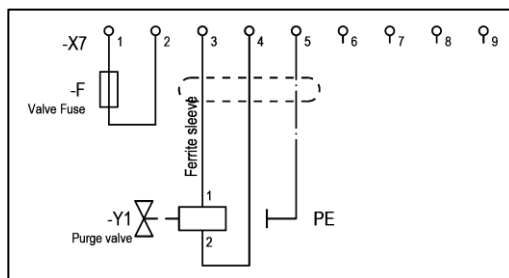

The terminal row X7 is used to connect the purge gas valve and the accompanying valve fuse. Furthermore, the terminal points 6 – 9 are intended for unused wires of the LAN connection cable.

Terminal	Connection	Function
1	Pre-fuse	Connection pre-fuse valve
2	Pre-fuse	Connection pre-fuse valve
3	Valve +	+ conductor valve
4	Valve -	GND valve
5	Valve - PE	PE valve
6	L1 BU	For unused LAN cable wire
7	L2 BUWH	For unused LAN cable wire
8	L3 BNWH	For unused LAN cable wire
9	L4 BN	For unused LAN cable wire

## 6.2.1.6 Terminal row "X6"

**ATTENTION****MATERIAL DAMAGE DUE TO INCORRECT PRE-FUSING.**

Valve or control electronics may be damaged.

- Operate the digital outlet valve only with a 1.0 A pre-fuse and the proportional outlet valve only with a 1.6 A pre-fuse.

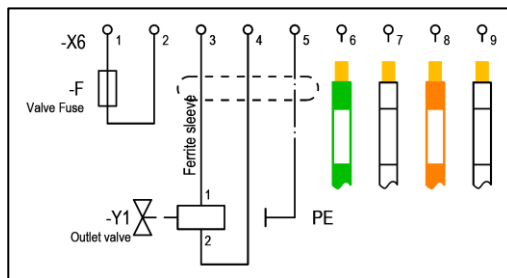

The terminal row X6 is used to connect the outlet valve and the accompanying valve fuse. Furthermore, the terminal points 6 – 9 are intended for the LAN connection cable.

Terminal	Connection	Function
1	Pre-fuse	Connection pre-fuse valve
2	Pre-fuse	Connection pre-fuse valve
3	Valve +	+ conductor valve
4	Valve -	GND valve
5	Valve - PE	PE valve
Connection of the original programming cable		
6	L1 GN	Send, negative
7	L2 GNWH	Send, positive
8	L3 OG	Receive, negative
9	L4 OGWH	Receive, positive

## 6.2.2 Connection terminals “Ex i”

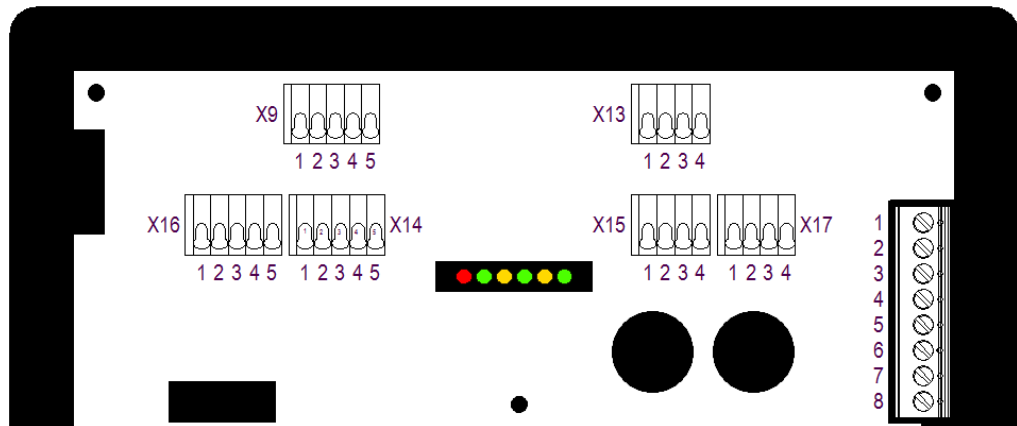

### 6.2.2.1 Terminal row “X9”

#### **!** DANGER

**DEATH OR SERIOUS PHYSICAL INJURY DUE TO COMMISSIONING WITH BYPASS KEY SWITCH IN POTENTIALLY EXPLOSIVE ATMOSPHERE.**

Risk of explosion.

- ▶ Have the commissioning with a bypass key switch approved by the factory manager or his representative. Approval may only be given if it has been ensured that there will not be any explosive atmosphere for the duration of the commissioning or if the necessary precautions have been taken to protect against the risk of explosion (fire permit).
- ▶ A marking on the bypass key switch that the Ex protection will no longer exist if the key switch is activated must be affixed in the direct vicinity of the key switch.

The bypass key switch can be connected separately to the Ex p control unit.

The bypass key switch must be marked as shown in the following label and must be attached in the immediate vicinity of the bypass key switch.

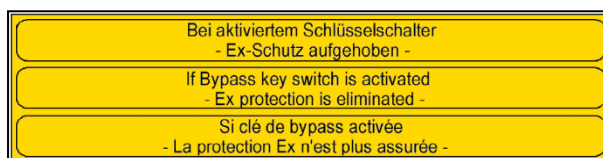

The position of the bypass key switch is requested with intrinsic safety by control electronics.



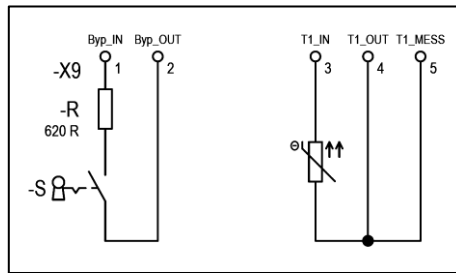

For the bypass switch to be detected and the function to be executed, a resistor with 620  $\Omega$  must be connected to the closing contact.

The temperature sensor can be a PT 100 or 1000. Settings for the sensor are made in the device. Two or three wire sensors can be used.

Terminal	Connection	Function
1	Bypass IN	Contact for the bypass switch
2	Bypass OUT	Contact for the bypass switch
3	T-Sensor 1 IN	Temperature sensor connection
4	T Sensor 1 OUT	Temperature sensor connection
5	T Sensor 1 MESS	Temperature sensor connection

### 6.2.2.2 Terminal row “X14”

As an additional enable, an enable switch can be connected after the control unit APEX has given the enable.

This function gives the enable when the control unit is enabled and the main switch is activated.

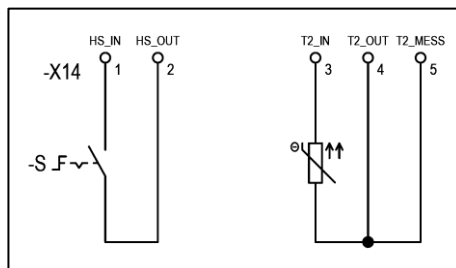

The main switch does not require a combination of resistors.

The temperature sensor can be a PT 100 or 1000. Settings for the sensor are made in the device. Two or three wire sensors can be used.

Terminal	Connection	Function
1	Main switch IN	Contact for the main switch
2	Main switch OUT	Contact for the main switch
3	T sensor 2 IN	Temperature sensor connection
4	T sensor 2 OUT	Temperature sensor connection
5	T sensor 2 MESS	Temperature sensor connection

### 6.2.2.3 Terminal row “X16”

#### **⚠ WARNING**

**RISK OF DEATH OR INJURY DUE TO UNINTENTIONAL ALTERATION OF THE EX-RELEVANT PARAMETERS.**

Explosion protection is no longer guaranteed.

- ▶ Remove the programming enable again after deliberately changing parameters.
- ▶ After changing or adapting parameters, a subsequent functional test must be performed.

The programming enable must be connected and activated in order to change settings and set point values on the device.

It must only be connected during the deliberate modification of parameters.

After changing or adapting parameters, a final function test must be performed.

During normal operation of the Ex p system it may not be connected.

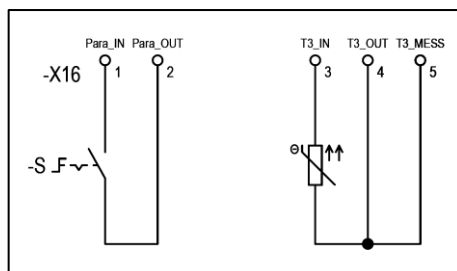

The BARTEC parameter-setting switch must be used to change the parameters.

The temperature sensor can be a PT 100 or 1000. Settings for the sensor are made in the device. Two or three wire sensors can be used.

Terminal	Connection	Function
1	Parameter IN	Contact for the parameter setting switch
2	Parameter OUT	Contact for the parameter setting switch
3	T sensor 3 IN	Temperature sensor connection
4	T sensor 3 OUT	Temperature sensor connection
5	T sensor 3 MESS	Temperature sensor connection

## 6.2.2.4 Terminal row “X13”

**ATTENTION****ATTENTION WHEN CONNECTING EXTERNAL SENSORS TO THE EX P CONTROL UNIT.**

Ensure functional safety when connecting external sensors to the Ex p control unit!

- ▶ The external sensors must meet the requirements placed on SIL 2.

Two functions can be executed at the optional current input as standard.

Firstly, an additional pressure sensor can be connected or a current signal can be used to trigger purging without deactivation.

Pressure sensor for additional pressure monitoring. The function is set via the WEB interface.

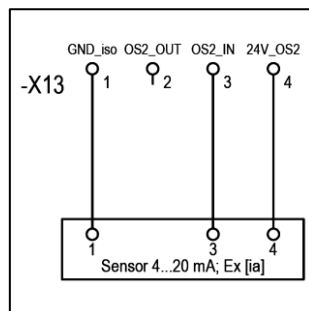

Pressure or gas sensors with 4...20 mA output can be connected to the sensor input OS 2 [Ex ia].

The signal is processed depending on the setting of the functions

Terminal	Connection	Function
1	GNDiso	Ground connection
2	OS2 Out	Sensor output
3	OS2 IN	Sensor input
4	24V OS2	Power supply sensor 2

### 6.2.2.5 Terminal row “X15”

#### ATTENTION

#### ATTENTION WHEN CONNECTING EXTERNAL SENSORS TO THE EX P CONTROL UNIT.

Ensure functional safety when connecting external sensors to the Ex p control unit!

- ▶ The external sensors must meet the requirements placed on SIL 2.

Two functions can be executed at the optional current input as standard.

Firstly, an additional pressure sensor can be connected or a current signal can be used to trigger purging without deactivation.

Pressure sensor for additional pressure monitoring. The function is set via the WEB interface.

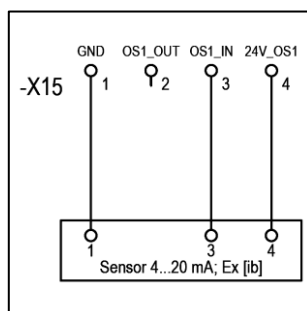

Pressure or gas sensors with 4...20 mA output can be connected to the sensor input OS 1 [Ex ib].

The signal is processed depending on the setting of the functions.

Terminal	Connection	Function
1	GND	Ground connection
2	OS1 Out	Sensor output
3	OS1 IN	Sensor input
4	24V OS1	Power supply sensor 1

## 6.2.2.6 Terminal row “X17”

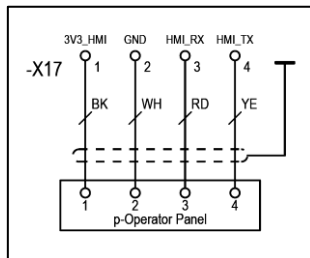

The optionally available p operator panel can be connected to the terminal row “X17”.

Terminal	Connection	Wire	Function
1	3V3V_HMI	BK	Power supply
2	GND	WH	Ground connection
3	HMI_RX	RD	Data cable
4	HMI_TX	YE	Data cable

## 6.2.2.7 Terminal row – measurement card

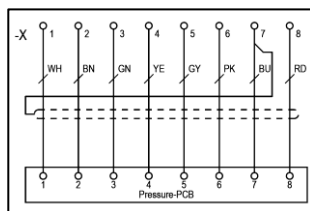

The pressure sensor board belonging to the Ex p control unit is connected to the terminal row (screw connection).

Terminal	Connection	Wire	Function
1	SCL_H1	WH	Data cable
2	SDA_H1	BN	Data cable
3	3V3_H1	GN	Power supply channel 1
4	SCL_H2	YE	Data cable
5	SDA_H2	GY	Data cable
6	3V3_H2	PK	Power supply channel 2
7	GND	BU	GND
8	Diagnosis	RD	Diagnostic cable

## 7 Operation

Operation of the Ex p control unit for end users is described in the following chapters. A description of the configuration and settings is provided in separate operating instructions.

The complete solution starts automatically after connecting the purge gas supply and the supply voltage. System statuses can be queried via the WEB interface.

### 7.1 WEB interface

The Ex p control station is supplied with a fixed IP address as standard.

Standard IP address (factory default): 192.168.11.101

The following options are available to establish a connection between laptop and PC.

Laptop (192.168.11.99 // 255.255.0.0)



Ex p Control Unit (192.168.11.101)

#### 7.1.1 Adjusting the LAN connection

Settings for the LAN interface on the PC (or converter / managed switch) must be programmed so that it can communicate with the Ex p control unit.

Settings:

Configuration of the LAN interface:

- ➔ Extended / speed: 100 Mbps full duplex

Properties of internet protocol Ver. 4 (TCP/IPv4):

- ➔ Activation of fixed IP address
- ➔ IP address: 192.168.11.99
- ➔ Subnet mask: 255.255.0.0

**Procedure:**

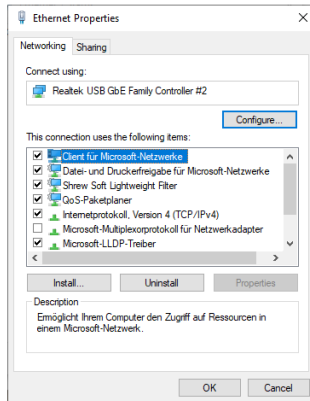

Open the network settings for the LAN interface on the PC/laptop.

Select the properties of the LAN connection by pressing the “Properties” button.

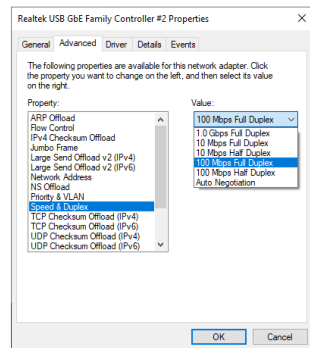

Open the network adapter settings using the “Configure...” button and select Advanced.

Select the “Speed & Duplex” function in the left-hand “Property” box

Set the value in the right-hand “Value” box to “100 Mb Full Duplex“ by clicking and selecting this in the drop-down menu

Confirm changes by clicking “OK“.

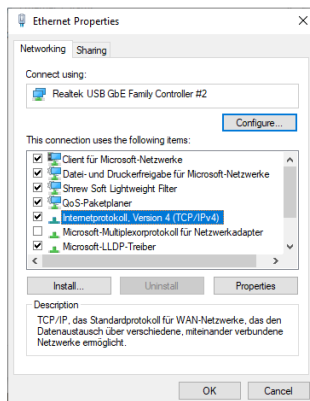

Call up Internet Protocol Version 4 (TCP/IP4) with a double-click

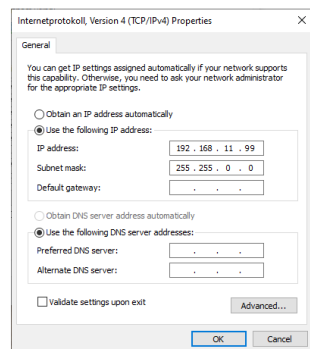

Properties of internet protocol Version 4 (TCP/IPv4):

Click to change “Obtain IP address automatically“ to “Use following IP address”.

Enter IP address 192.168.11.99 for the “IP address“  
Enter subnet mask 255.255.0.0.

Confirm entries with OK.

## 7.2 Operation of the WEB interface

The web interface is operated using the input devices on the PC.

## 7.3 Logging onto the WEB interface

Two login levels are available on the WEB interface

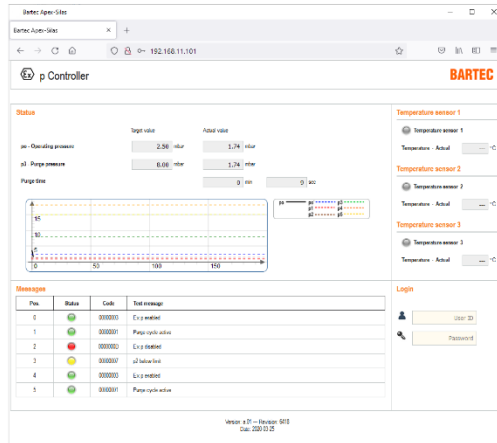

**Level 1 = Guest access**

User ID = guest

Password = guest

**NB:** No changes can be made to the settings. A change of language, status query and messages are possible.

**Level 2 = User access**

User ID = user

Password = 0000

**NB:** Settings can be changed in conjunction with a set programming switch.

## 7.4 Navigation in the WEB interface

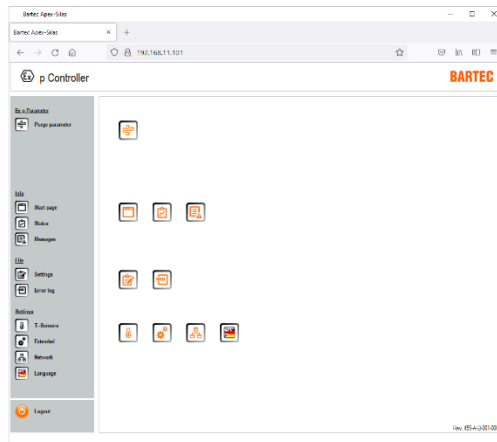

By clicking on the left-hand grey navigation bar, you can jump directly to specific submenus.

The relevant icons for the submenus are arranged to the left of this.

The icon to log out is found in the bottom left-hand corner of the screen. The web interface logs off when the button is pressed, and switches to the login view.

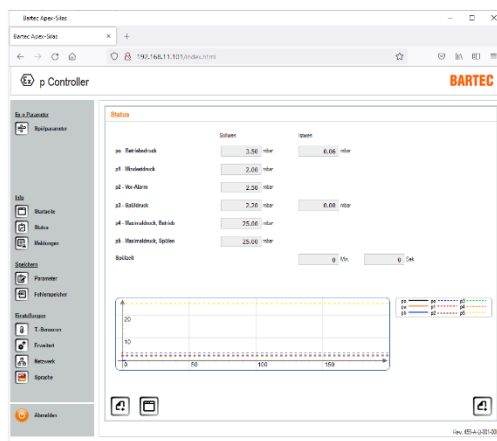

Three icons are arranged in the lower area of the submenus; these have the function Next / Back and home page.



## 7.5 Input of parameters

Changing parameters in the Web interface must be carried out in a certain sequence:

Procedure for changing parameters:

- ▶ Activate the parameter setting switch.
- ▶ Logging in to the web interface  
If you are already logged in, the web interface requires a new log-in.
- ▶ Select desired parameter  
👉 e.g. po - operating pressure 2.5 mbar (250 Pa)
- ▶ Enter parameters  
👉 Enter value 250
- ▶ Press the "Enter" key to confirm.
- ▶ The following window opens. This is to confirm and check the changed parameter value.

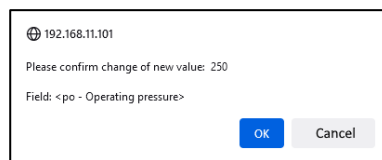

## 7.6 LED Indicators

LED	Color	Function
p1	Green	Minimum pressure → Lights up when the minimum pressure is exceeded
p2	Yellow	Pre alarm → Lights up when the value falls below the set value
p3	Green	Purge pressure → Lights up during rinse phase and exceeds set point value
p4	Red	Maximum pressure → Lights up when the maximum pressure is exceeded p4 or p5
Operate	Green	Release / purge process → Flashing during purge and on release after flushing lit
Status	Green	Power Supply / Bypass → Lights up when supply voltage is applied and flashes when bypass is activated

## 7.7 Menu structure WEB-Interface

The WEB interface integrated in the Ex p control unit shows the following menu structure:

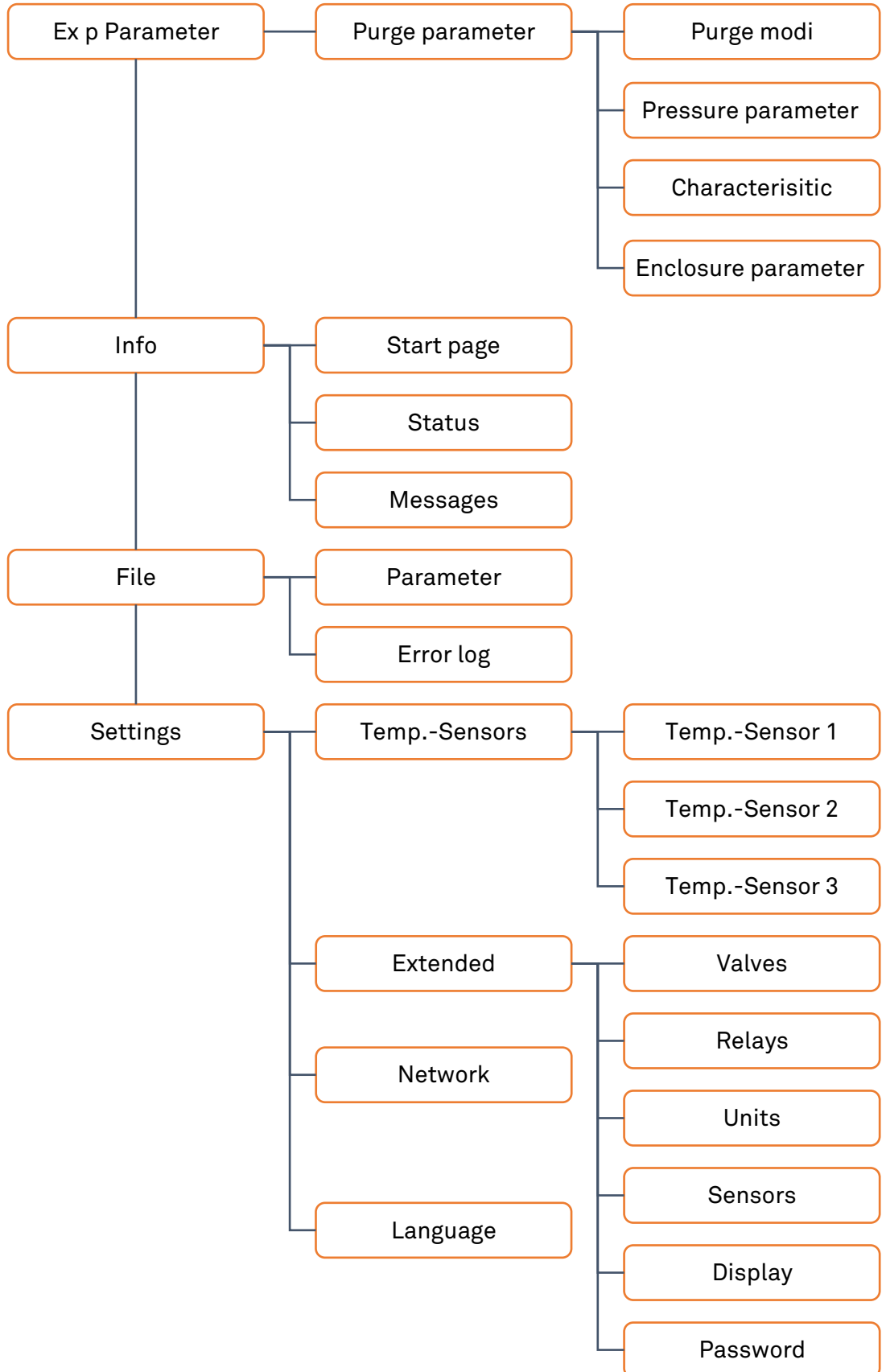



Purge programs gas application:

Program	Use	Functions				
		Purge phase	Purge time starts when p3 is exceeded	Purge time stops when p5 is reached	Ex p active after	Ex p inactive after
Ex_p_1	Gas	Yes	Yes	Yes	Expiration purge time	po < p1 po > p4
Ex_p_2	Gas	Yes	Yes	Yes	Expiration purge time	po < p1
Ex_p_4	Gas	Yes	Yes	No	Expiration purge time	po < p1 po > p4
Ex_p_5	Gas	Yes	Yes	No	Expiration purge time	po < p1

Ex p programs dust application:

Program	Use	Functions				
		Purge phase	Purge time starts when p3 is exceeded	Purge time stops when p5 is reached	Ex p active after	Ex p inactive after
Ex_pD_1	Dust	No	No	No	po >= p1	po < p1 po > p4
Ex_pD_2	Dust	No	No	No	po >= p1	po < p1

7.8.1.2 Pressure parameter

The system pressures of the Ex p equipment are defined in the "Pressure parameter" submenu.

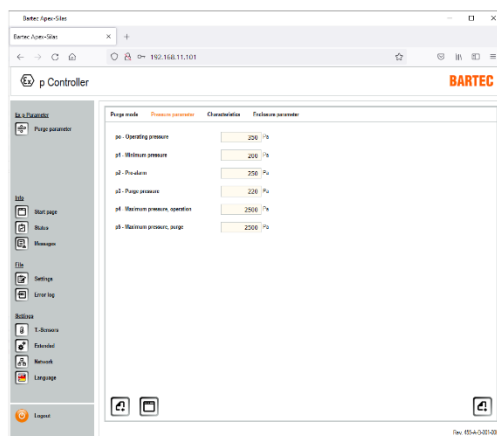

po = Operating pressure. Pressure value at which control takes place during the operating phase.

p1 = Minimum pressure. Shut-off value; if the pressure falls below this value, the enable is reset.

p2 = Pre-alarm. Value at which an alarm can be given before shutdown.

p3 = Purge pressure. Purge time starts when the set point is exceeded.

p4 = Maximum pressure, operation. Depending on the selection of the purge program, there is a shutdown or message.

p5 = Maximum pressure, purge. Depending on the selection of the purge program, there is a shutdown or message.

### 7.8.1.3 Characteristic

**! DANGER**

**INCORRECT PARAMETERIZATION OF THE SYSTEM COMPONENTS IN THE EX P CONTROL UNIT.**

The purge process takes place with too low purge gas flow and there is a risk of residual explosive gases within the Ex p equipment.

- Check type and set characteristic

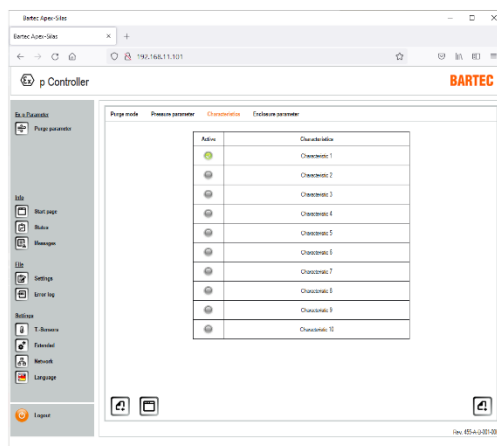

For automatic purge time determination, the characteristics of the pressure switch in the system must be set in the Ex p control unit.

**Selection table**

Parameter	Measuring orifice	BARTEC outlet type
Characteristic 1	18 mm	17-51P3-1603
Characteristic 2	2x 18 mm	2x 17-51P3-1603

### 7.8.1.4 Enclosure parameter

#### **! DANGER**

#### **INCORRECT PARAMETERIZATION OF THE PROTECTED VOLUME IN THE EXP CONTROL UNIT.**

The purge process takes place with too low purge gas flow and there is a risk of residual explosive gases within the Exp equipment.

- ▶ Check enclosure size and volume.

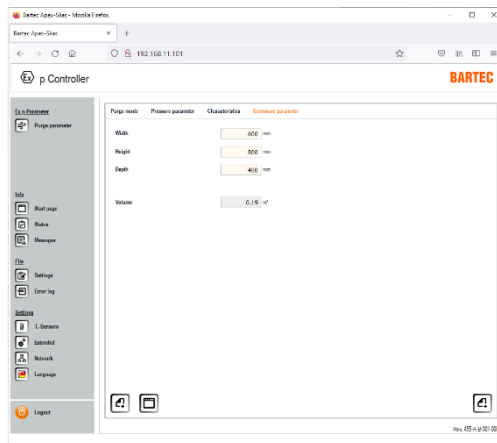

For automatic purge time determination, the size of the protected volume must be set in the Exp control unit.

This is done by entering the width, height and depth in mm.

### 7.8.2 Start page

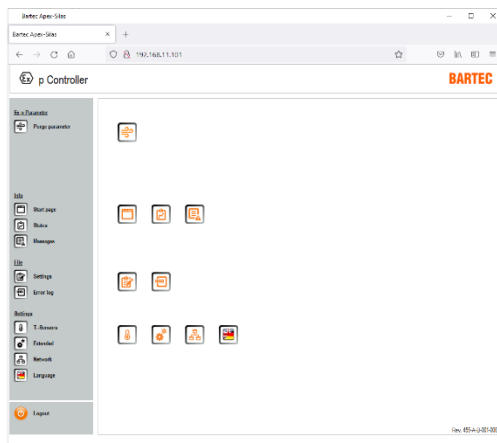

You can quickly return to the start page via the "Info / Start page" menu.

Furthermore, all system information can be called up via the "Status" or "Messages" menu.

### 7.8.3 Status

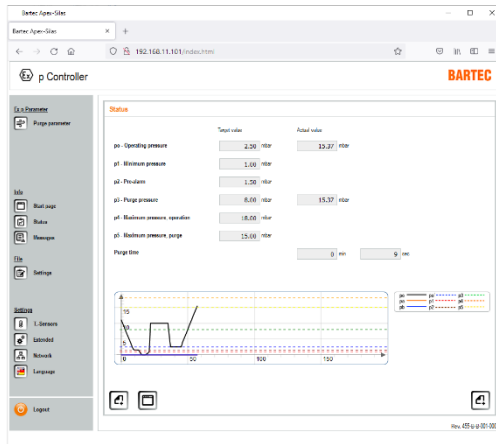

In the "Info / Status" menu, an overview of the setpoint and measured values is displayed.

Furthermore, there is an internal pressure diagram in the lower area.

### 7.8.4 Messages

ID	Status	Code	Text message
0	Green	000000	Purge cycle active
1	Red	000000	Cx-a disabled
2	Yellow	000007	pl-below limit
3	Green	000000	Cx-a enabled
4	Green	000001	Purge cycle active
5	Red	000000	Cx-a disabled
6	Yellow	000007	pl-below limit
7	Green	000000	Cx-a enabled
8	Green	000001	Purge cycle active
9	Red	000000	Cx-a disabled

In the "Info / Messages" menu, the current system status is displayed as a plain text message.

Green messages = Positive

Yellow messages = Warning

Red messages = Error messages

### 7.8.5 Parameter

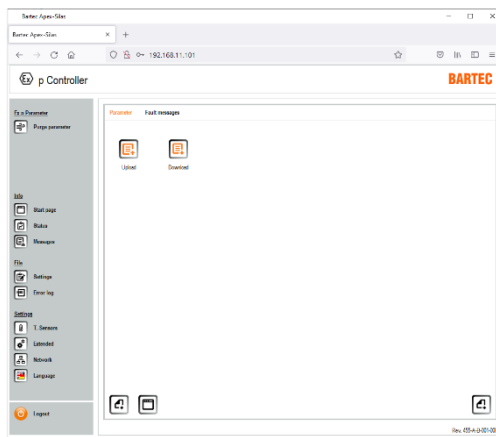

Within the "Save / Parameters" menu, parameters from the Ex p control unit can be saved on a local computer or transferred from the local computer to the Ex p control unit.

Upload = Transfer local parameter set to the Ex p control unit.

Download = Save parameter set from Ex p control unit to local computer.

## 7.8.6 Error log

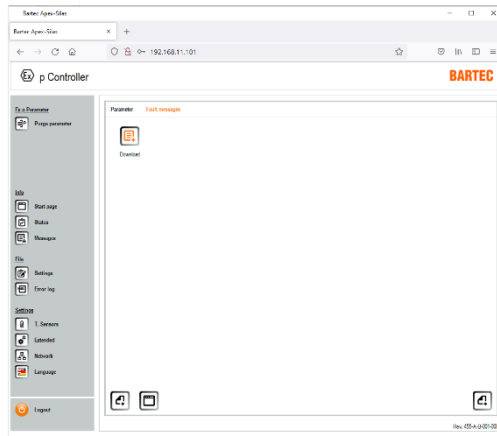

Furthermore, there is the option of reading out the error memory in the "Save / Error memory" menu.

Save = Local loading of the error memory.

The file is transferred to the local computer as a \*.csv file. This can be opened using Microsoft Excel.

## 7.8.7 Temperature sensors

Up to three temperature sensors in the PT100 or 1000 version can be connected to the Ex p control unit.

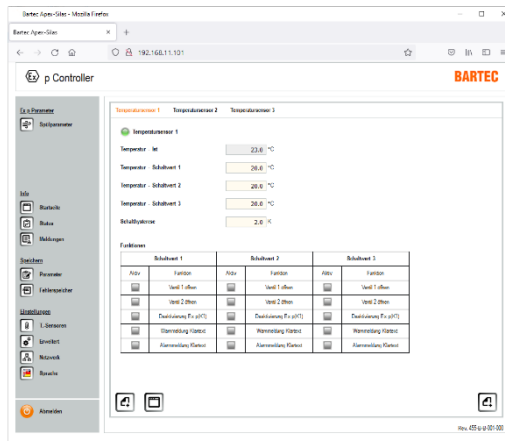

In the menu "T. sensors" up to three PT100/1000 sensors can be configured.

Various functions can be executed in the control sequence for the recorded temperature.

This function can be used e.g. for monitoring frequency converters.

### Parameters







Parameter	Function
Temperature – actual	Displays the measured temperature
Temperature switching value 1	The assigned function is executed on exceeding the switching value
Temperature switching value 2	The assigned function is executed on exceeding the switching value
Temperature switching value 3	The assigned function is executed on exceeding the switching value
Switching hysteresis	The switching hysteresis between activation and deactivation of the assigned function



**Functions**

Switching value	Function
Open valve 1	Cooling using purging air
Open valve 2	Cooling using valve 2, e.g. vortex
Deactivating of Ex p (K1)	The enable is withdrawn on exceeding the temperature
Warning in plain text	A plain text warning is issued in the messages area on exceeding the temperature
Plain text alarm message	A plain text alarm is issued in the messages area on exceeding the temperature

**7.8.7.1 Setting “Temperature sensors“****Procedure**

- ▶ Connect the computer to the Ex p control unit / control station
- ▶ Activate the programming switch
- ▶ Log into the WEB interface at the user level
- ▶ Select the Extended / sensors menu
- ▶ Activate the corresponding button for the required temperature sensor, e.g. temperature sensor 1, by clicking PT100 or 1000  
Manual button changes to   
Confirm the pop-up window with changed value
- ▶ Select the display unit in °C or °F by clicking and activating the button.  
Display changes to   
Confirm the pop-up window with changed value
- ▶ Select the T-sensors / temperature sensor 1 menu
- ▶ The signal for the active sensor is displayed by the green detector 
- ▶ Save switching value 1  
 e.g. 25 °C
- ▶ Confirm the pop-up window with changed value
- ▶ Save switching value 2  
 e.g. 35 °C
- ▶ Confirm the pop-up window with changed value
- ▶ Save switching value 3  
 e.g. 60 °C
- ▶ Confirm the pop-up window with changed value
- ▶ Save switching hysteresis  
 e.g. 5 K → functions will be activated and deactivated at a hysteresis of 5K

- ▶ Select a function for switching value 1  
👉 e.g. open valve 1 → function “Cooling using purging air”
- ▶ Confirm the pop-up window with changed value
- ▶ Select a function for switching value 2  
👉 e.g. plain text warning → function “Warning is issued as plain text message”
- ▶ Confirm the pop-up window with changed value
- ▶ Select a function for switching value 3  
👉 e.g. deactivation of Ex p (K1) and plain text alarm message → function “Withdrawal of the enable for the Ex p equipment and the issuing of a plain text alarm message“
- ▶ Confirm the pop-up window with changed value.

## 7.8.8 Extended

### 7.8.8.1 Valves

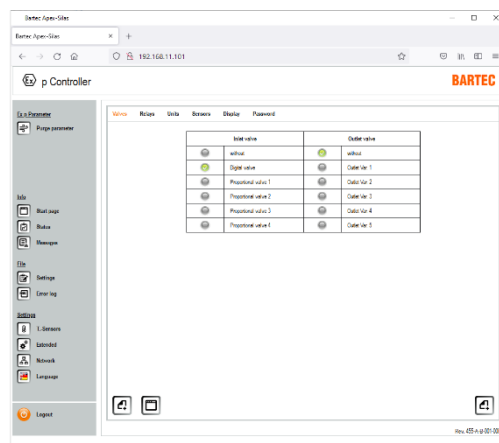

Im Menüpunkt „Ventile“ können das am Ex p Steuergerät angeschlossene Spülgasventil eingestellt werden.

Der Auslieferungszustand ist in der Einstellung Digitalventil.

Das jeweils aktivierte Spülgasventil ist mit folgendem Zeichen gekennzeichnet: ✔

Inlet valve		Outlet valve	
Selection code	Type	Selection code	Type
-	without	Active	Without
05-0056-0073	Digital valve		Not used
03-5110-0095	Proportional valve 1		Not used
05-0056-0081	Proportional valve 2		Not used

7.8.8.2 Relays

**ATTENTION**

**ATTENTION WHEN SWITCHING PARAMETER K2 WITH K1**

When using relay K2 as an enable relay (parameter K1), other selected parameters are not utilized because at this time relay K2 is regarded as an enable relay (SIL related)

- ▶ Assign messages to signaling relays K3 and K4

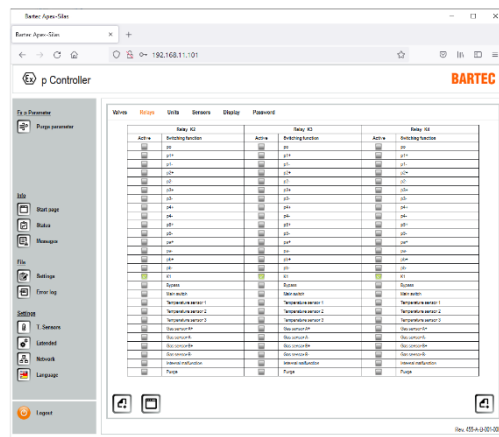

In the "Relay" menu item, the relays K2, K3 and K4 can be provided with the associated switching functions. One or more switching functions can be assigned to each relay.

The delivery state is in the setting switch with K1.

The respectively activated switching function is marked with the following sign:

Messages with a “minus sign” indicate that the relay is activated when falling below a set level.

Messages with a “plus sign” indicate that the relay is activated when exceeding a set level.

**Procedure:**

- ▶ Connect the computer to the Ex p control unit
- ▶ Activate the programming switch
- ▶ Log into the WEB interface at the user level
- ▶ Select the Extended / relay menu
- ▶ In the "of the respective relay" column, activate the specific message(s) by clicking on the related button.  
 e.g. click button “K1“; The button changes from to
- ▶ Confirm the pop-up window with changed value
- ▶ Deactivate the programming switch

### 7.8.8.3 Units

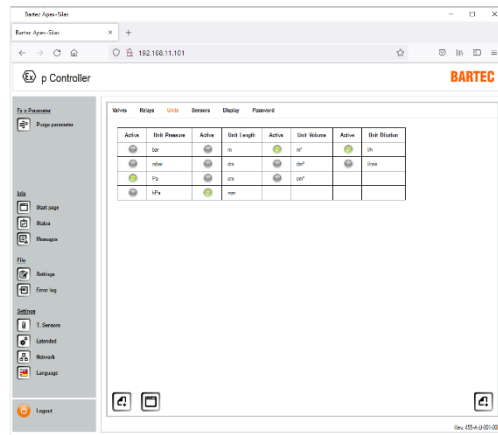

In the "Units of measurement" menu item, the display units can be selected for pressure, length, volume and dilution.

### 7.8.8.4 Sensors

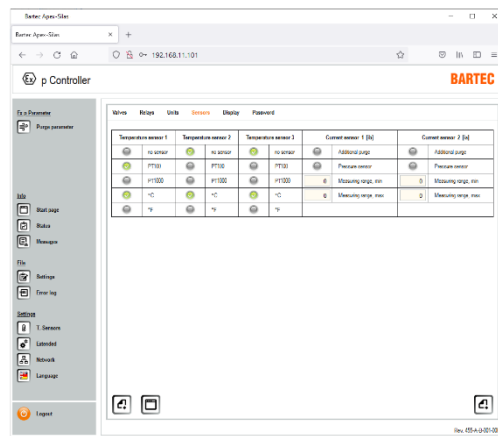

In the menu item "Sensors" the three additional temperature sensors can be activated.

In addition, the OS1 and OS 2 current sensors can be activated.

In the standard version, the sensor inputs OS1 and OS2 can be provided with an "additional pressure monitoring" or with an "additional purging" function

### Application as "additional pressure monitoring"

The APEX Ex p control unit with additional pressure monitoring is based on the standard version. Purging and the operating phase takes place in the same way.

The difference to the standard version is seen during the operating phase; the control unit uses two optionally connected pressure sensors to additionally monitor the equipment in terms of minimum pressure during the operating phase.

#### Procedure:

- ▶ Connect the computer to the Ex p control unit
- ▶ Activate the programming switch
- ▶ Log into the WEB interface at the user level
  - ☞ Select the "Extended / sensors" menu
  - ☞ In the table shown you can activate the "Pressure sensor" function under Current sensor 1 or Current sensor 2. The minimum and maximum measurement range of the sensor must also be entered.
- ▶ Confirm the pop-up window with changed value(s)



### 7.8.8.6 Menu „Password”

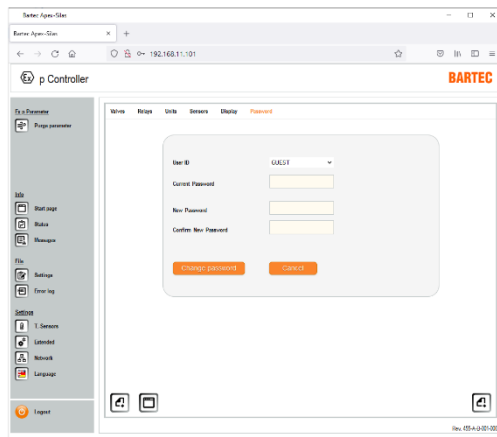

A new password can be stored for the Guest and User in the Password tab.

### 7.8.9 Menu „Network“

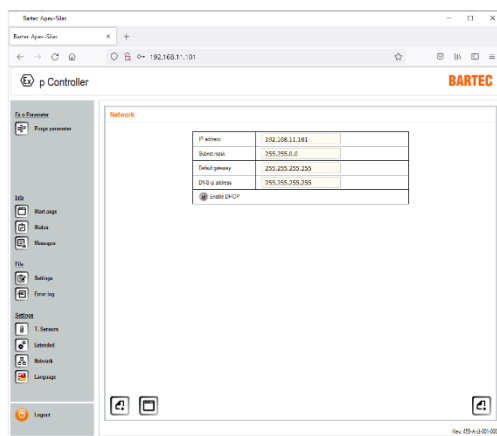

All network specific settings are made in the Network menu.

By default, the Ex p control unit is set to a static IP address. It is also possible to activate a DHCP mode.

### 7.8.10 Menu „Language“

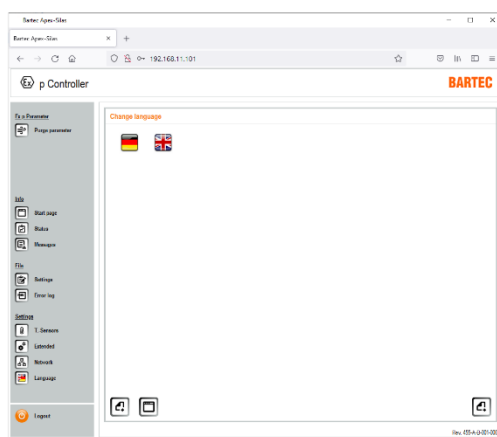

In the "Language" menu, the system language can be selected between German and English.

## 7.9 System status

By connecting the laptop to the Ex p control unit, initial information about the system keyboard can be called up on the start screen.

### Procedure for querying the system status

- Logging into WEB interface by opening the browser and entering the IP address 192.168.11.101

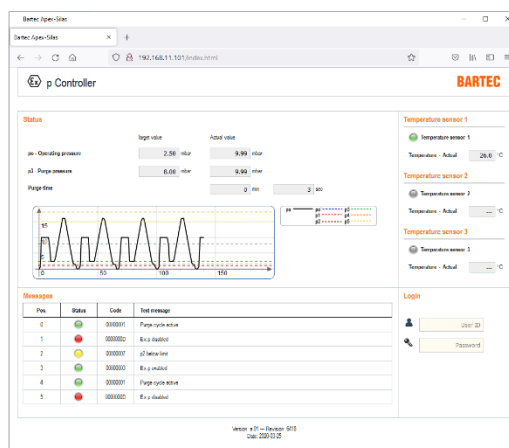

The start screen provides an initial overview of the status of the Ex p system.

In the upper left area, the set values for po and p3 and the corresponding measured values are displayed.

Furthermore, plain text messages, pressure diagram and, in the case of opt. connected temperature sensors, the values are displayed.

Additional information or download / display of the error memory can be done by logging into the user login.

- Read error memory
- Logging in to the WEB interface with the user level

- ☞ Call up the "Error log" menu
- ☞ Click on the Save ICON

- CSV file with the error memory content is downloaded and can be opened using Excel.

## 7.10 Reading container data

Data is retrieved for the control room via a web browser or using an appropriate software tool to be provided by the customer that is able to send an HTML GET message equivalent to a browser request across the network to the APEX device.

The data format returned from the device is JSON  
(see [https://de.wikipedia.org/wiki/JavaScript\\_Object\\_Notation](https://de.wikipedia.org/wiki/JavaScript_Object_Notation))

Request:

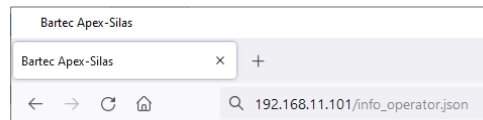

Data for the control room can be retrieved using the URL:

 `http://<ip-addr>/info_operator.json`

e.g. `http://192.169.1.101/info_operator.json`

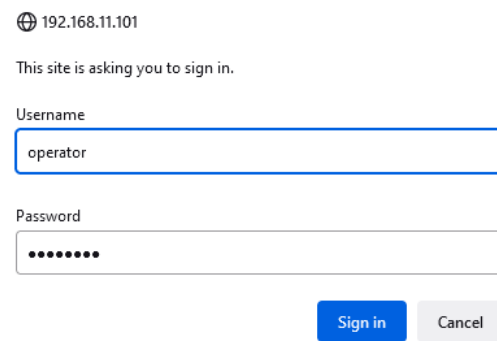

The username and password must be entered.

Login: “operator”  
Password: “operator”

Reply from the control unit:

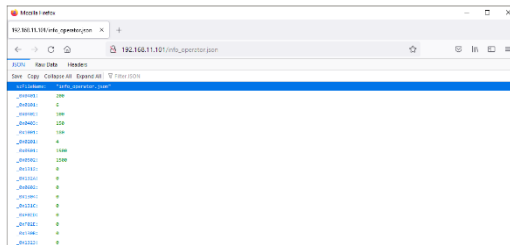

Code table:

Key/ID	Parameter	Unit
_0x0401	Operating pressure po (setpoint)	Pa
_0x0101	Operating pressure po (actual)	Pa
_0x0402	Minimum pressure (shutdown pressure level)	Pa
_0x0403	Pre-alarm (switching value)	Pa
_0x1001	Purge pressure p3 (setpoint)	Pa
_0x0201	Purge pressure p3 (actual)	Pa
_0x0501	Maximum pressure, operation p4 (switching value)	Pa
_0x0502	Maximum pressure, purge p5 (switching value)	Pa
_0x1312	Pressure sensor A pa (actual)	Pa
_0x132A	Pressure sensor B pb (actual)	Pa
_0x0602	Purge time	Seconds



## 8 Commissioning

### 8.1 General

The following sections describe the initial commissioning of the Ex p control unit. This means that it is described in detail how the Ex p control unit is set to the Ex p equipment created.



#### COMMISSIONING

The operating instructions for the Ex p equipment must be used for commissioning a set and certified Ex p equipment.

### 8.2 Sequence for the settings

The following procedure is recommended when setting the function parameters:

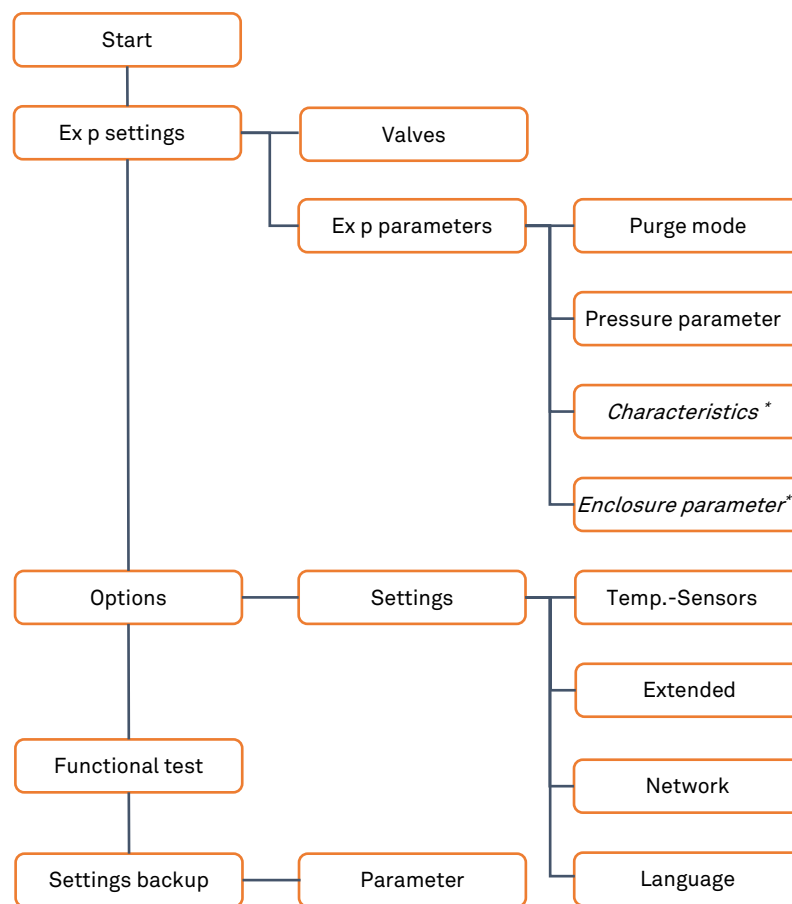

\* = Setting is to be performed in case of automatic flushing

### 8.3 Parameterization of purge gas valve

For the Ex p control unit, purging gas valves are available in the "Proportional" or "Digital" version. The difference between the two purging gas valve types is the mode of operation:

Digital purging gas valve = on/off valve. Leakage air compensation takes place via the setting of the manually adjustable leakage air needle.

Proportional valve = regulating valve. During the purging phase, the internal pressure is regulated to 87.5% of p<sub>5</sub> and during the operating phase to p<sub>0</sub>.

### 8.3.1 Setting for "Leakage air compensation" digital valves



When using digital purge gas valves, the leakage air needle must be adjusted during initial startup or when the leakage air quantity changes.

With proportional valves, the leakage air volume is controlled automatically via the valve.

This must be set so that enough purge gas enters the pressurized equipment to maintain the required operating pressure ( $p_o$ ).

The leakage air needles are located on each side of the valve body on the valve.

The side that may not be accessible should be closed.

#### Procedure

- ▶ Set the pressurized equipment in an operationally safe manner.
- ▶ Measure the internal pressure via a pressure gauge or use the Ex p control unit for pressure acquisition
- ▶ Close pressurized equipment, activate purge gas supply
- ▶ Read off the resulting internal pressure on the gauge
  - 👉 If the internal pressure is too low, increase the amount of purge gas at the leakage air needle valve. This is done by turning counterclockwise
  - 👉 If the internal pressure is too high, reduce the amount of purge gas at the leakage air needle. This is done by turning the leakage air needle clockwise.

## 8.4 Configuration for gas applications

Ensure that the electrical wiring has been connected as described in the relevant operating instructions and that the purge gas supply has been connected.



If the Ex p control unit is in programming mode (parameter switch activated and password entered), the display of the pressure values is in Pa. Settings are made in the Pa.

To carry out the configuration, log into the WEB interface at the user level.

### 8.4.1 Ex p settings – Manual purge

After the applied purge gas valve is set, the Ex p specific parameters are set according to the following sections.

Follow the individual chapters for the correct procedure to the parameters to be performed.

### 8.4.1.1 Setting the “Purge program / Purge mode”

#### DANGER

#### DEATH OR SERIOUS BODILY INJURY FROM USE OF AN IMPROPER FLUSH MODE.

Explosion risk.





- ▶ Only activate rinsing programs suitable for the application.
- ▶ Purge programs Ex\_p\_3, Ex\_p\_6, Ex\_M\_1 and Ex\_M\_2 are special purge modes, which must not be used for standard applications.

Within the "Purge parameters / Purge mode" web interface, the purge mode as well as the sequence control can be adjusted.



The precondition for all purge programs, so that the further phases are initiated, is that  $p_0 > p_1$  is.

#### Procedure

- ▶ Connect PC with Ex p control unit, activate programming switch
- ▶ Logging into the WEB interface with the user level
- ▶ Call up the Purge parameter / Purge mode menu
- ▶ Select purge program by clicking the left button
  -  Purge program Ex\_p\_1 by clicking the button
    - Button changes from  to 
- ▶ Confirm pop-up window with changed value
- ▶ Purge mode should be set to " Manuel" for the purge described here.

### 8.4.1.2 Setting the “Purge time”



The procedure described here for determining the purging time is based on the principle of manual purging time calculation

Assumptions for the determination of the purge time:

- All relevant parameters are assumed values -

#### ➔ Ex control with application digital purge gas valve

When using a digital purging gas valve, reaching the purge pressure  $p_3$  is set by means of the mechanical limitation of the purging gas nozzle. The table in section 5.4 shows guideline values for the bore diameters based on the protected enclosure volume.

In deviation from this table, the purging gas nozzle can also be drilled out step by step to achieve the desired purge pressure  $p_3$ .



As the drilling diameter of the purging gas nozzle increases, the volume of purging gas supplied increases and thus the purging pressure  $p_3$  achieved is greater.

**→ Ex p control with application proportional purge gas valve**

When using a proportional purge gas valve, the achieved purge pressure p3 is achieved by adjusting the internal pressure to the value 7/8 of p5.

This means that the internal pressure can be finely adjusted during purging with the aid of the proportional valve, which can be advantageous for pressure-sensitive assemblies in the front of the pressurized equipment.

**Procedure**

- ▶ Connect PC with Ex p control unit, activate programming switch
- ▶ Login to the WEB interface with the user level
- ▶ Call up the Purge parameter / Pressure parameter menu
- ▶ Pressure parameter p3 - set purge pressure to 2000 Pa (20 mbar)
  - Pop-up window with display of changed value appears, Confirm
- ▶ Pressure parameter p5 - maximum pressure, purge set to the value, which the pressurized equipment is allowed during purging, e.g. set 2000 Pa (20 mbar).
  - Pop-up window with display of changed value appears, Confirm
  -  During the purging phase, the Ex p control unit regulates to the internal pressure to 7/8 of p5 when a proportional valve is used.
  - Means that with this setting, the internal pressure during the purging phase is 17.5 mbar. If 20 mbar is exceeded during the purging phase, the purging gas valve is closed. The further behavior depends on the setting of the purge mode.
- ▶ Deactivate programming switch
  - Ex p Control unit changes from programming mode to control/monitoring mode.
- ▶ Press the "F5" key of the PC to refresh the browser window.
- ▶ Start screen opens.
- ▶ Note the actual value of the p3 purge pressure, as example 10 mbar.
  -  Operating instructions Chapter Opening the purge air diagram
  -  Read out the corresponding flow rate Q as a function of the determined p3 from the diagram. As example 15 000 l/hUsing the formula
$$t [\text{min}] = ((V [\text{l}] \times \text{factor purging}) / Q [\text{l/h}]) \times 60$$
$$2 \text{ min} = ((100 \text{ l} \times 5 \text{ times purging}) / 15000 \text{ l/h}) \times 60$$
- ▶ Pop-up window with display of changed value appears, Confirm
- ▶ Activate programming switch
- ▶ Login into the WEB interface with the user level
- ▶ Call up the Purge parameter / Pressure parameter menu
- ▶ Pressure parameter p3 - Set purge pressure to determined value
  - Pop-up window with display of changed value appears, Confirm
- ▶ Call up the Purge parameter / Purge mode menu
- ▶ Set the purge time to the calculated purge time
  - Pop-up window with display of changed value appears, Confirm

### 8.4.1.3 Setting the “Ex p parameters / pressure parameters”

- The pressure parameters to be observed are part of IEC / EN 60079-2.
-  Furthermore, the pressure parameters are application-dependent and must be checked during initial commissioning.

The following values can be applied as a basic setting:

$p_0 = 2.5 \text{ mbar (250 Pa)}$



$p_1 = 1.0 \text{ mbar (100 Pa)}$

$p_2 = 1.5 \text{ mbar (150 Pa)}$

$p_3 =$  Determination by chapter 3.2

$p_4 =$  Application-dependent, e.g. pressure-sensitive components?

$p_5 =$  Application-dependent, e.g. pressure-sensitive components?

- ▶ Connect PC with Ex p control unit, activate programming switch
  - ▶ Login to the WEB interface with the user level
  - ▶ Call up the Purge parameter / Pressure parameter menu
  - ▶ Enter and confirm the "p<sub>0</sub> - operating overpressure" parameter
    -  e.g. 250 Pa (2.5 mbar)
    - The value "p<sub>0</sub>" is the internal operating overpressure of the pressurized enclosure. This value is monitored by the Ex p control unit and compensated if necessary.
    - Pop-up window with display changed value opens
  - ▶ Confirm pop-up window with changed value
  - ▶ Enter and confirm pressure parameter "p<sub>1</sub> - minimum pressure"
    -  e.g. 100 Pa (1.0 mbar)
    - Pop-up window with display changed value opens
  - ▶ Confirm pop-up window with changed value
  - ▶ Enter and confirm pressure parameter "p<sub>2</sub> - Pre-alarm"
    -  e.g. 150 Pa (1.5 mbar)
    - Pop-up window with display changed value opens
  - ▶ Confirm pop-up window with changed value
- ... Follow the same procedure for the other pressure parameters
- ▶ Deactivate programming switch

## 8.4.2 Ex p settings – Automatic purge

### 8.4.2.1 Setting the “Purge program / Purge mode”

#### DANGER

**DEATH OR SERIOUS BODILY INJURY FROM USE OF AN IMPROPER FLUSH MODE.**

Explosion risk.









- ▶ Only activate purge programs suitable for the application.
- ▶ Purge programs Ex\_p\_3, Ex\_p\_6, Ex\_M\_1 and Ex\_M\_2 are special purge modes which must not be used for standard applications.

Within the "Purge parameters / Purge mode" web interface, the purge mode as well as the sequence control can be adjusted.



The precondition for all purge programs, so that the further phases are initiated, is that  $po > p1$  is.

#### Procedure

- ▶ Connect PC with Ex p control unit, activate programming switch
- ▶ Logging into the WEB interface with the user level
- ▶ Call up the Purge parameter / Purge mode menu
- ▶ Select purge program by clicking the left button
  -  Purge program Ex\_p\_1 by clicking the button
    - Button changes from  to 
- ▶ Confirm pop-up window with changed value
- ▶ Activate the purge mode to " Automatic" by clicking on the button.
  -  by clicking the button
    - Button changes from  to 
    - Confirm pop-up window with changed value
- ▶ Enter the desired purge factor
  -  The purge factor indicates how often the protected volume is to be purged. E.g. 5-fold purge means that a protected volume of 100 liters is purged with at least 500 liters of purge gas.
  -  Enter the value "5" and confirm with Enter
    - Confirm pop-up window with changed value

### 8.4.2.2 Setting the “Ex p parameters / pressure parameters“



The pressure parameters to be observed are part of IEC / EN 60079-2.

Furthermore, the pressure parameters are application-dependent and must be checked during initial commissioning.

The following values can be applied as a basic setting:

$p_0 = 2.5 \text{ mbar (250 Pa)}$

$p_1 = 1.0 \text{ mbar (100 Pa)}$

$p_2 = 1.5 \text{ mbar (150 Pa)}$

$p_3 = \text{Automatic determination by Ex p control unit}$

$p_4 / p_5 = \text{Application-dependent, e.g. pressure-sensitive components?}$

#### Procedure

- ▶ Connect PC with Ex p control unit, activate programming switch
- ▶ Login to the WEB interface with the user level
- ▶ Call up the Purge parameter / Pressure parameter menu
- ▶ Enter and confirm the "po - operating overpressure" parameter
  - 👉 e.g. 250 Pa (2.5 mbar)
  - The value "po" is the internal operating overpressure of the pressurized enclosure. This value is monitored by the Ex p control unit and compensated if necessary.
  - Pop-up window with display changed value opens
- ▶ Confirm pop-up window with changed value
- ▶ Enter and confirm pressure parameter "p1 - minimum pressure"
  - 👉 e.g. 100 Pa (1.0 mbar)
  - Pop-up window with display changed value opens
- ▶ Confirm pop-up window with changed value
- ▶ Enter and confirm pressure parameter "p2 - Pre-alarm"
  - 👉 e.g. 150 Pa (1.5 mbar)
  - Pop-up window with display changed value opens
- ▶ Confirm pop-up window with changed value
- ... Follow the same procedure for the other pressure parameters
- ▶ Deactivate programming switch

### 8.4.2.3 Setting the “Exp p parameters / characteristics”

#### **WARNING**

**RISK OF DEATH OR INJURY CAUSED BY SETTING THE CHARACTERISTICS INCORRECTLY.**

The explosion protection is no longer guaranteed.

- ▶ Check the type number and corresponding characteristics of the pressure monitor.

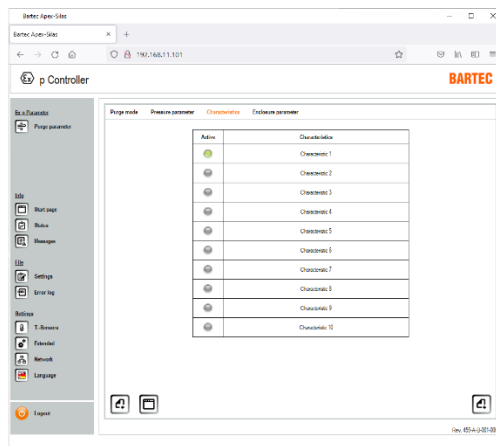

The particular pressure monitor installed is defined in the “Characteristics” tab.

This must be correctly adjusted in order to correctly calculate the purge time.

The pressure monitor used can be selected by clicking the button (🟢).

The selection table is described in chapter 7.8.1.3.

### 8.4.2.4 Setting the “Exp p parameters / enclosure parameters”



If the Exp p control unit is in programming mode (parameter switch has been activated and a password entered), the measurement units are displayed in mm.

Settings are entered in mm.

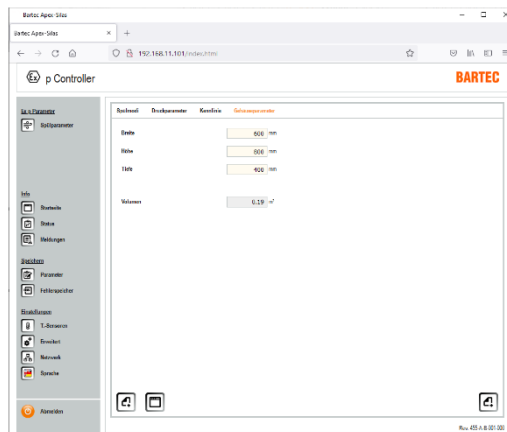

In dem Reiter „Gehäuseparameter“ wird das interne Volumen des überdruckgekapselten Betriebsmittels festgelegt.



## 8.5 Configuration for dust applications



Ensure that the electrical wiring has been connected as described in the relevant operating instructions and that the purge gas supply has been connected.

To carry out the configuration, log into the WEB interface at the user level. The structure of the chapters corresponds to the flow diagram in Chapter 7.1, and can therefore be worked through chapter by chapter.

### 8.5.1 Exp settings

Follow the individual chapters for the correct procedure to the parameters to be performed.

#### 8.5.1.1 Setting the "Purge program / Purge mode"



#### DANGER

**DEATH OR SERIOUS BODILY INJURY FROM USE OF AN IMPROPER FLUSH MODE.**

Explosion risk.



- ▶ Only activate rinsing programs suitable for the application.
- ▶ Purge programs Ex\_pD\_3, Ex\_M\_1 and Ex\_M\_2 are special purge modes which must not be used for standard applications.

Within the "Purge parameter / Purge mode" web interface, the purge mode as well as the sequence control can be adjusted.



The precondition for all purge programs, so that the further phases are initiated, is that  $p_o > p_1$  is.

#### Procedure

- ▶ Connect PC with Exp control unit, activate programming switch
- ▶ Logging into the WEB interface with the user level
- ▶ Call up the Purge parameter / Purge mode menu
- ▶ Select the applied purge program by clicking the left button
  - ▶  Purge program Ex\_pD\_1 by clicking the button
    - Button changes from  to 
- ▶ Confirm pop-up window with changed value
- ▶ Purge mode should be set to "Manuel" for the purge described here.

### 8.5.1.2 Setting the “Purge gas valve“

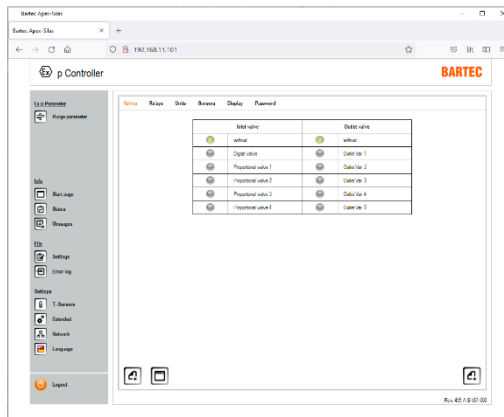

Due to the fact that no purging is performed in Ex pD (dust) applications, the purging gas valve is replaced by an adjustable purging gas nozzle.

To ensure that the control unit does not activate a valve, the setting "without" must be adopted in the corresponding WEB-Interface menu "Extended / Valves".

Inlet- and Outlet valve are set to "without".

### 8.5.1.3 Setting the “Ex p parameters / pressure parameter“

The pressure parameters to be observed are part of



IEC / EN 60079-2.

Furthermore, the pressure parameters are application-dependent and must be checked during initial commissioning.

The following values can be applied as a basic setting:

po = 1.5 mbar (150 Pa)

p1 = 1.0 mbar (100 Pa); p2 = 1.2 mbar (120 Pa)

p3 = not applied for dust applications



p4 = 5.0 mbar (500 Pa); P5 = 5.0 mbar (500 Pa)

#### Procedure

- ▶ Connect PC with Ex p control unit, activate programming switch
- ▶ Login to the WEB interface with the user level
- ▶ Call up the Purge parameter / Pressure parameter menu
- ▶ Enter and confirm the "po - operating overpressure" parameter

 e.g. 250 Pa (2.5 mbar)

The value "po" is the internal operating overpressure of the pressurized enclosure. This value is monitored by the Ex p control unit and compensated if necessary.

- Pop-up window with display changed value opens
- ▶ Confirm pop-up window with changed value
- ▶ Enter and confirm pressure parameter "p1 - minimum pressure"
  -  e.g. 100 Pa (1.0 mbar)
  - Pop-up window with display changed value opens
- ▶ Confirm pop-up window with changed value
- ▶ Enter and confirm pressure parameter "p2 - Pre-alarm"
  -  e.g. 120 Pa (1.2 mbar)

- ▶ Confirm pop-up window with changed value
- ... Follow the same procedure for the other pressure parameters
- ▶ Deactivate programming switch

## 9 Functional test and procedure

### 9.1 Safety during operation

#### DANGER

**DEATH OR SERIOUS INJURY CAUSED BY DAMAGED EXPLOSION PROTECTION MEASURE.**

Safe operation of the control unit is no longer possible.

Risk of an explosion

- ▶ Deactivate the APEX control unit and secure to prevent it restarting.

### 9.2 Functional flow diagram for the Ex p control station

Operation of pressurized equipment can be divided into two or three phases. With gas applications there are three phases, while with dust applications there are just two because the purge phase is replaced here by manual cleaning.

#### 9.2.1 Ex p control flow chart

#### DANGER

**RISK OF DEATH OR SERIOUS INJURY WHEN INCORRECTLY SETTING THE PRESSURE PARAMETERS**

Risk of an explosion.

- ▶ Set the pressure parameters carefully and conduct a functional test.

With the previous chapters the required parameters and functions were defined and stored to the control unit.

The following parameters have been defined.

- > Purge program / Purge mode
- > Operating pressure for the Ex p equipment (p<sub>0</sub>)
- > Shutdown when pressure falls below minimum (p<sub>1</sub>)
- > Pre-alarm for minimum pressure (p<sub>2</sub>)
- > Purge pressure (p<sub>3</sub>), depending on "Manual / Automatic" purge modes
- > Maximum pressures during operation and purge (p<sub>4</sub> and p<sub>5</sub>), depending on applied rinsing program
- > Applied pressure outlet device, for automatic purging
- > Volume of protected Ex p equipment, for automatic purging

The Ex p control executes the following sequence during commissioning:

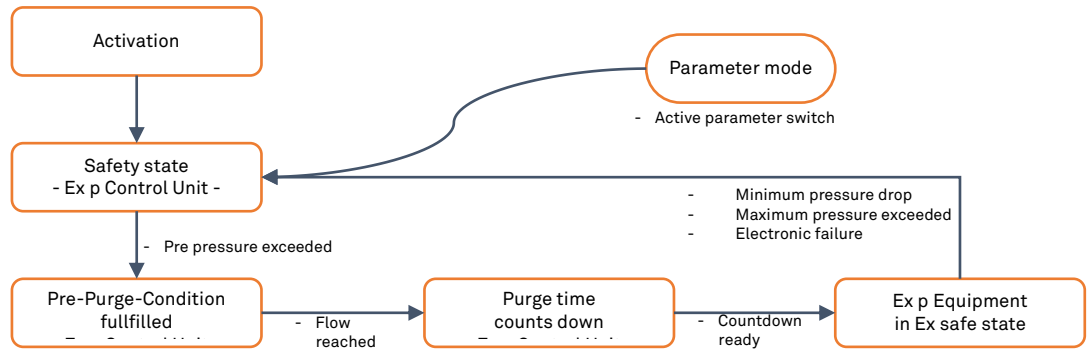

### 9.2.2 Functional flow diagram – dust

#### **⚠ DANGER**

#### **RISK OF DEATH OR SERIOUS INJURY WHEN INCORRECTLY SETTING THE PRESSURE PARAMETERS**

Risk of an explosion.

- ▶ Set the pressure parameters carefully and conduct a functional test.

With the previous chapters, the required parameters and functions were defined and stored to the control unit.

The following parameters have been defined.

- > Purge program / Purge mode
- > Operating pressure for the Ex p equipment (p<sub>0</sub>)
- > Shutdown when pressure falls below minimum (p<sub>1</sub>)
- > Pre-alarm for minimum pressure (p<sub>2</sub>)
- > Maximum pressures during operation and purge (p<sub>4</sub> and p<sub>5</sub>), depending on applied rinsing program

The Ex p control executes the following sequence during commissioning:

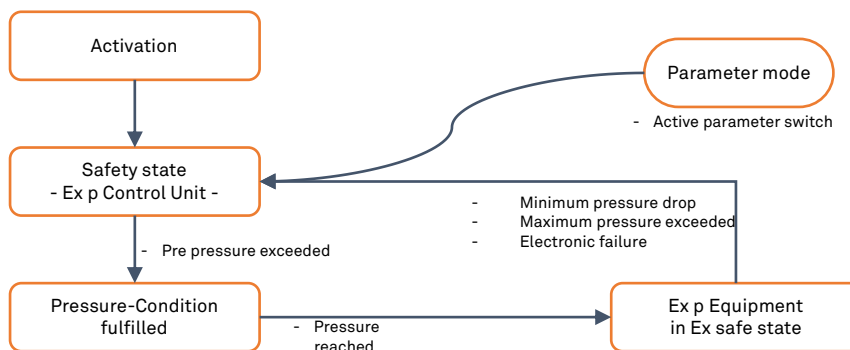

## 10 Maintenance and care



Find out about the general safety instructions before starting work (see Chapter 2.4 Safety instructions).

Carry out maintenance and care in accordance with the following sections, unless otherwise agreed for customer-specific versions.

### 10.1 Types of purging gas

Only inert gas (e.g. nitrogen) or purified and dry instrument air is permitted as purging gas. In any case, a filter must be installed upstream if the quality with regard to foreign particles is not guaranteed. The following quality characteristics of the purging gas should be met:

- ➔ Residual dust: < 40 µm
- ➔ Residual water: dew point +3 °C
- ➔ Residual oil content: 1 mg/m<sup>3</sup>

### 10.2 Maintenance work

#### 10.2.1 Maintenance intervals

##### MAINTENANCE INTERVALS



Maintenance according to the following maintenance schedule is recommended in the case of proper operation, observing the installation instructions and ambient conditions.

#### ATTENTION

##### MAINTENANCE AND CARE

- ▶ The currently applicable regulations and the national provisions must be observed for maintenance, service and inspection of the equipment!
- ▶ Operation and maintenance work may be performed by trained specialist personnel only. The statutory regulations and the other binding directives on occupational health and safety, accident prevention and environmental protection must be observed.
- ▶ When opening covers or removing parts, unless possible by hand, live parts may be exposed. Connecting parts may also be live.

Maintenance interval	Work to be performed
Monthly	Visual inspection according to Chapter 10.2.2
Semi-annually	Cleaning according to Chapter 10.2.3
Annually	Regular maintenance according to Chapter 10.2.4

### 10.2.2 Visual inspection

Perform a visual inspection monthly by:

- ▶ Checking the enclosure, cable entries and cables for damage.
- ▶ Checking the screwed connections for tight fit.
- ▶ Checking the error memory for content.

### 10.2.3 Cleaning

No solvents should be used to clean the control unit as these can impair the properties on contact with the seals.

### 10.2.4 Regular maintenance

Depending on the purity of purging air used, the inlet and outlet of the control unit must be checked regularly for impurities (e.g. oil, dust, etc.) or corrosion.

In the case of anomalies, the operator should weigh up the possibility of a timely and proper cleaning by BARTEC GmbH against a spontaneous failure of the control unit.

Furthermore, the function of the overall system should be checked. The correct sequence of the purging phase and of the operating phase should be checked.

## 10.3 Repairs

Repairs to the control unit and accessories may only be made by BARTEC GmbH.

## 10.4 Faults and troubleshooting

### ATTENTION

**AN ALTERED OPERATING BEHAVIOUR CAN BE AN INDICATION OF ALREADY EXISTING DAMAGE TO THE CONTROL UNIT.**

- ▶ Only put the Ex p system back into operation after the cause of a fault has been rectified.

It is assumed that all external electrical and mechanical equipment have been properly connected. Therefore, the correct installation and connection of the electrical devices should be checked first.

## 10.4.1 Faults

Error / Fault	Possible cause	Remedy
Sporadic failure	Cable break	Check connections
	Pressure drop / leakage	Check tightness and leak compensation
Control unit without function (all LEDs off)	Mains voltage not available	Check supply voltage
	Device defective	Return to manufacturer
The protected devices are switched on without pre-purging	Bypass activated	Deactivate bypass
	Incorrect purging program activated	Check purging program
During pre-purging, the purging gas valve switches off for a short time	Excessive amounts of purging gas are introduced into the pressurized enclosure	Reduce the purging gas nozzle
"Operate" LED does not flash during purging time	No purging gas	Check purging gas valve for the presence of supply voltage
	Purging gas valve does not open or opens only partially	Check purging gas valve for foreign particles in the mechanical part
		Increase inlet pressure to set point value
	An insufficient amount of purging gas flows through the Ex p enclosure	Check purging gas nozzle for correct value
		Check set point values "p3" and "p1" of the control unit
		Increase the cross section of the purging gas supply line
		Purging gas supply line too small. Enlarge cross section of the supply line
	Set point pressure of the pressure reducer is not reached	Remove the cap or eliminate the reduction by taking suitable measures
Pressure monitor of the control unit is inadmissibly closed or has a reducer	Seal enclosure using suitable measures	
Enclosure leaks during the pre-purging phase due to increased internal pressure	Check purging gas valve for the presence of supply voltage	

Digital purging gas valve does not switch to the small nozzle after the pre-purging phase	Temperature sensor is connected, internal temperature too high	Check purging gas valve for foreign particles in the mechanical part Wait until the increased flow rate has caused the internal temperature to drop or check the set temperature switching value
	Main switch or bridge to the terminals Hs_In / Hs_Out not connected	Switch on main switch or connect bridge to terminal Hs_In / Hs_Out
	Purging gas valve does not close	Check purging gas valve for disconnected supply voltage
Control unit does not switch on the electrical devices after the pre-purging phase	Pressure in the enclosure higher than the switching value "p4"	Reduce the flow rate of the air leak needle
	Switching value "p4" too low	Check switching value "p4"
	Pressurized enclosure leaking, switching value "p1" not reached	Seal pressurized enclosure
The control unit switches off the electrical devices after the purging time with a time delay	Leakage air needle of digital valve too small	Increase the air flow rate of the leakage air needle
	Switching value "p3" too high	Check switching value "p3"
Relays K4 or K5 do not switch	Wrong selection of switching parameters	Check switching parameters
Digital purging gas valve switches on briefly during the operating phase	Value "po" too high	Reduce "po" value
	Pressurized enclosure leaking, switching value "p1" not reached	Seal pressurized enclosure
	Pressurized enclosure leaking, switching value "p1" not reached	Adjust leak compensation
If the pressure drops, the electrical devices do not switch off	Key switch switched on	Switch off key switch
	Wrong purge program selected	Correct purge program







## 10.4.2 Error messages









The control units give plain text messages which are divided into 3 categories.

- ▶ Positive messages are notifications that do not affect system availability.
- ▶ Warning messages are notifications that affect parts of the system.
- ▶ Alarm messages are notifications that lead to the shutdown of the protected device.















### 10.4.2.1 Positive messages

Status	Code	Plain text
	00000001	Purging cycle active
		The control unit has started the purging process.
	00000002	Exp ready
		The control unit has successfully completed the purging process. The main switch or bridge HS_IN / HS_OUT is not closed.
	00000003	Exp enabled
		The control unit has successfully completed the purging process. The main switch or bridge HS_IN / HS_OUT is closed and enabled.
	00000004	p3 reached
		The set point value “p3” purging flow is reached and the purging time counts down.

### 10.4.2.2 Warning messages

Status	Code	Plain text
	00000005	Bypass active
		The bypass is activated on the control unit.
	00000006	Door contact / main switch open
		The main switch or bridge HS_IN / HS_OUT is not closed.
	00000007	p2 not reached
		The set point value p2 “pre-alarm” is not reached.
	00000008	p4 exceeded
		The set point value p4 “Maximum pressure – operation” is exceeded.
	00000009	p5 exceeded
		The set point value p5 “Maximum pressure – Purging” is exceeded.
	0000000A	Temperature sensor 1 exceeded
		The set point temperature value at sensor 1 is exceeded.
	0000000B	Temperature sensor 2 exceeded
		The set point temperature value at sensor 2 is exceeded.
	0000000C	Temperature sensor 3 exceeded
		The set point temperature value at sensor 3 is exceeded.

### 10.4.2.3 Alarm messages

Status	Code	Plain text
	000000D	Exp inactive The protected device is deactivated.
	000000E	Device fault 1 HW test error (processors)
	000000F	Device fault 2 HW test error (barriers)
	0000010	Device fault 3 HW test error (internal temperature monitoring)
	0000011	Device fault 4 HW test error (Fatal)
	0000012	Sensor fault 1 HW test error (pressure sensor / sensor board status)
	0000013	Sensor fault 2 HW test error (opt. current sensors)
	0000014	Sensor fault 3 HW test error (ext. temperature sensors)
	0000015	p1 not reached The set point p1 "Min pressure" has not been reached.
	0000016	p3 not reached The set point p3 "Purging pressure" has not been reached.
	0000017	p4 exceeded The set point p4 "Maximum pressure – operation" is exceeded
	0000018	p5 exceeded The set point p5 "Maximum pressure – Purging" is exceeded.
	0000019	Temperature sensor 1 exceeded The set point temperature value at sensor 1 is exceeded.
	000001A	Temperature sensor 2 exceeded The set point temperature value at sensor 2 is exceeded.
	000001B	Temperature sensor 3 exceeded The set point temperature value at sensor 3 is exceeded.

## 11 Technical data

Parameters	Specifications
Product	APEX <sup>py</sup>
Type	07-37A2-2111/*520
EU type examination certificate	BVS 19 ATEX E 015 X
IECEX certification	IECEX BVS 19.0038X
EAC certification	EA3C RU C-DE.AЖ58.B.01809/21
ATEX Marking	Ⓔ II 2(1)G Ex eb mb ib [ib pyb] [ia Ga] IIC T5 / T4 Gb Ⓔ II 2(1)D Ex tb [ib pyb] [ia Da] IIIC T95°C / T130 °C Db
IECEX Marking	Ex eb mb ib [ib pyb] [ia Ga] IIC Gb Ex tb [ib pyb] [ia Da] IIIC T95°C / T130 °C Db
EAC Marking	1Ex e mb ib [ib py] [ia Ga] IIC T5 Gb X 1Ex e mb ib [ib py] [ia Ga] IIC T4 Gb X Ex tb [ib py] [ia Da] IIIC T95 °C Db X Ex tb [ib py] [ia Da] IIIC T130 °C Db X
Operating temperature range	-25 °C to +60 °C @T4; -25 °C to +50 °C @T5
Storage and transport	-25 °C to +60 °C
Mains voltage DC (variant)	24 Vdc to 44 Vdc, +/- 10 %
Mains voltage AC (variant)	100 Vac to 230 Vac, +/- 10%
Power consumption electronics	0.5 A – 1.5 A
Maximum power consumption	15 W (incl. purging valve)
Enable relay K1 (SIL)	2 non-floating NO contacts, 230 Vac @ 5 A (AC1) or 24 Vdc @ 5 A (DC1)
Enable relay K2 (SIL)	Floating, 4 x NO, 230 Vac @ 3 A, 24 Vdc @ 3 A
Signal relays K3 and K4	Floating, 1x changeover contact, 230 Vac @ 1 A, 24 Vdc @ 1 A
Pressure range	0 ... 25 mbar
Tolerance range	0 ... 25 mbar = ±0.4 mbar
Purging time	Up to max. 2 hours
Purging gas valve	Digital or proportional
Connection terminal "Ex e"	0.08 ... 2.5 mm <sup>2</sup> (28 ...12 AWG)
With wire end ferrule / plastic collar	0.25 ... 1.5 mm <sup>2</sup>
Connection terminal "Ex i"	0.20 ... 2.0 mm <sup>2</sup> (20 ...14 AWG)
With wire end ferrule / plastic collar	0.25 ... 0.75 mm <sup>2</sup>
Enclosure material	Stainless steel V4A
Cable glands	9x M20 brass nickel-plated (clamping range: 4 - 12 mm) 1x M16 brass nickel-plated (clamping range: 3 - 9 mm)
IP degree of protection	IP 64 in accordance with IEC/EN 60079-0 IP 66 in accordance with IEC/EN 60529
Dimensions	250 (W) x 300 (H) x 130 (D) mm
Weight	10.5 kg

## 12 Order numbers

### 12.1 Ex p control unit APEX, standard

Standard, stainless steel,

Ex p control unit APEX <sup>py</sup> , Type II, DC wide voltage range	07-37A2-2111/1520
Ex p control unit APEX <sup>py</sup> , Type II, AC wide voltage range	07-37A2-2111/2520

### 12.2 Pressure monitor module

Pressure monitor, standard

Pressure monitor; Ex p enclosure; orifice 18 mm	17-51P3-1603
---	--------------

### 12.3 Valve fuse

Valve fuse 1.0 A (Application for digital purging gas valve)	05-0080-1016
Valve fuse 1.6 A (Application for proportional purging gas valve)	05-0080-1017

### 12.4 Purge gas valve

Digital purge gas valve, brass, DC 24 V	05-0056-0073
Proportional purge gas valve, brass, DC 24 V	05-0080-0081

### 12.5 Operator panel

Permanently wired and installation	17-51P5-0111
Permanently wired and add-on mounted	17-51P5-1111
Mobile with plug-in connector	17-51P5-2111

### 12.6 Installation accessories

Hose, d=4 mm, polyamide	02-3730-0009
Mounting – Kit “Internal”	05-0091-0275
Mounting – Kit “External”	On request
Hose T-connector if two pressure monitors are used	03-6211-0013

### 12.7 Protective circuits

Protective measure for inductive loads

Overvoltage protection AC, ModEx, Ex db eb IIC	07-7311-93GU/K000
Free-wheeling diode, ModEx, Ex db eb IIC	07-7311-61GF/5400

## 13 Annex

### 13.1 Purge diagram

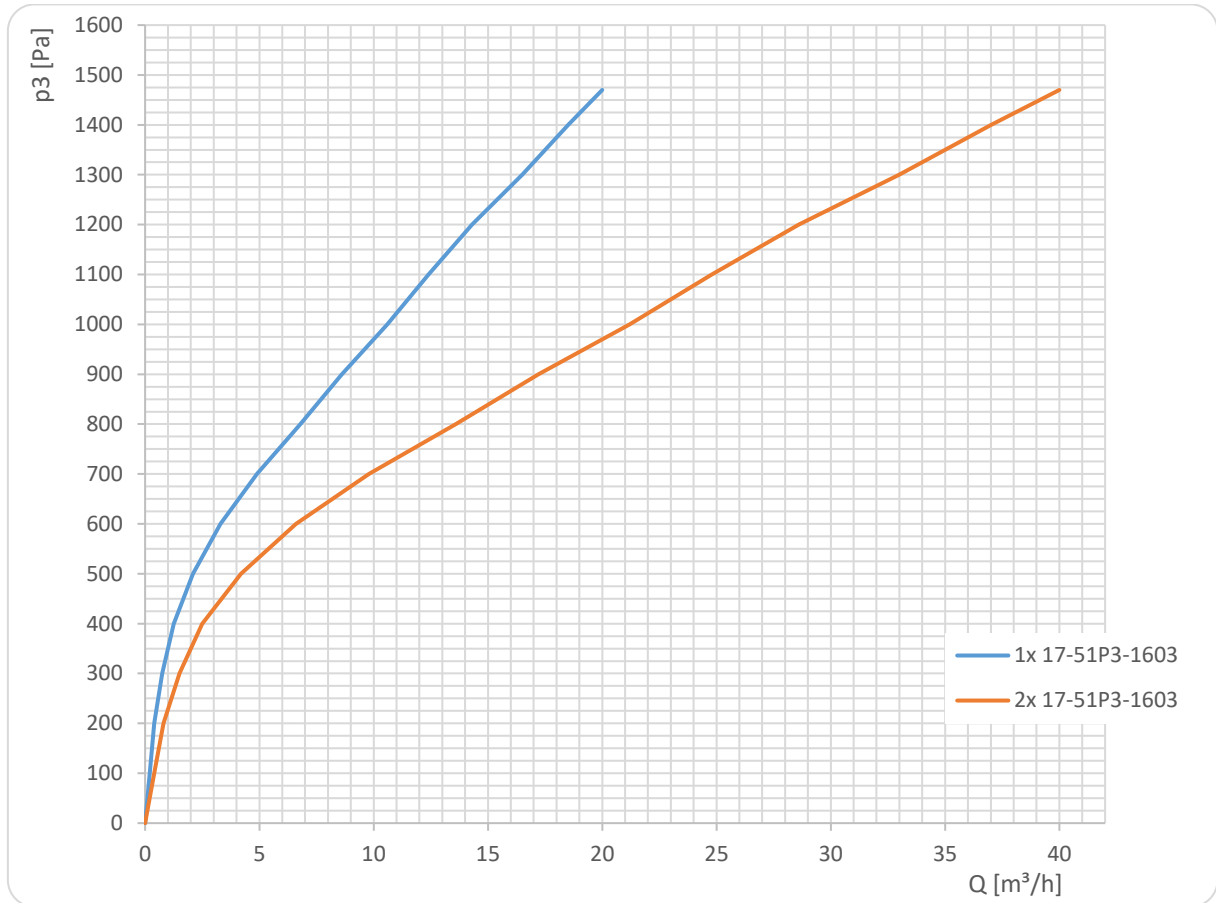

### 13.2 Sequence diagram

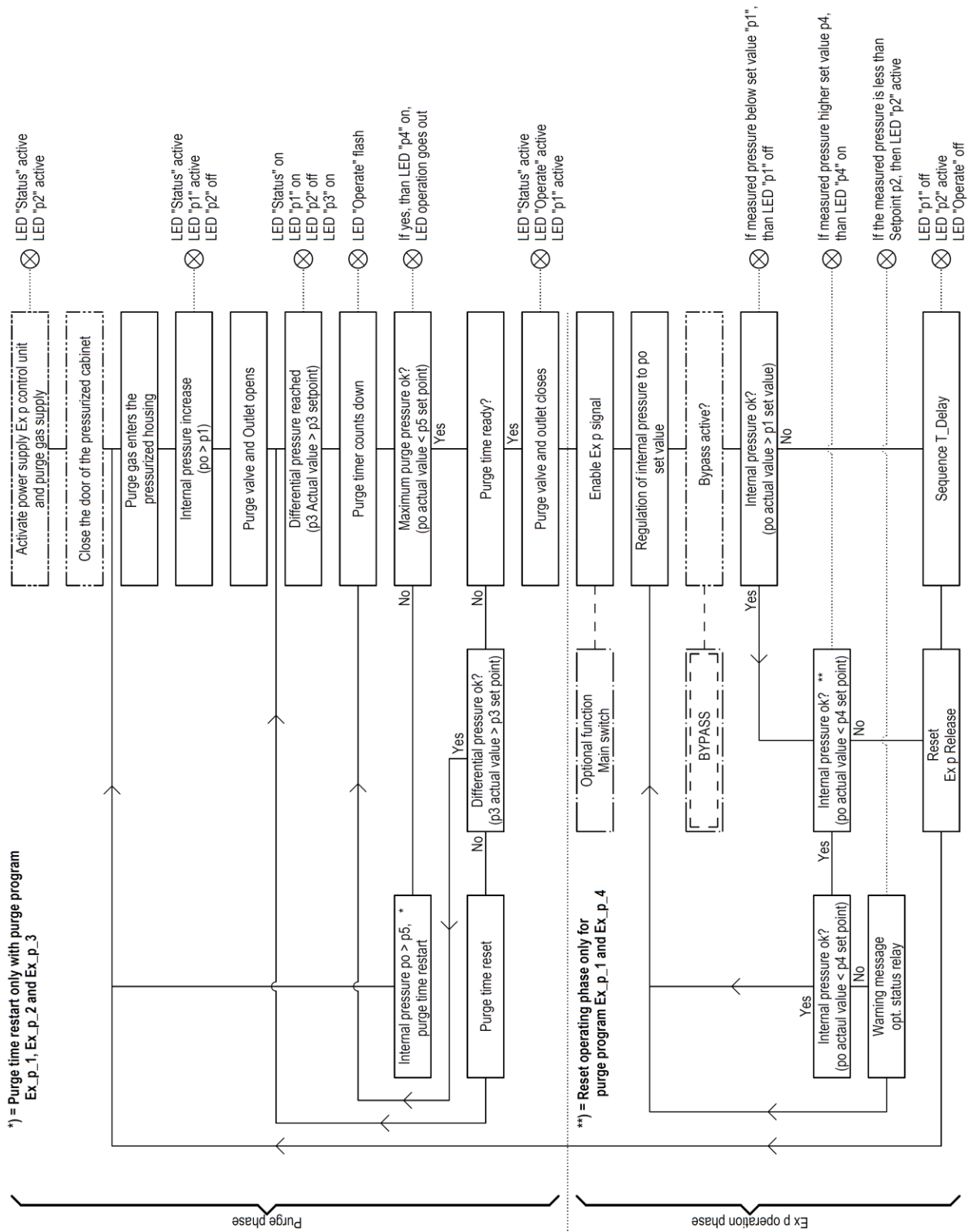

### 13.3 Dimensions

#### 13.3.1 Ex p control unit APEX<sup>px</sup>, 07-37A2-2111/\*520

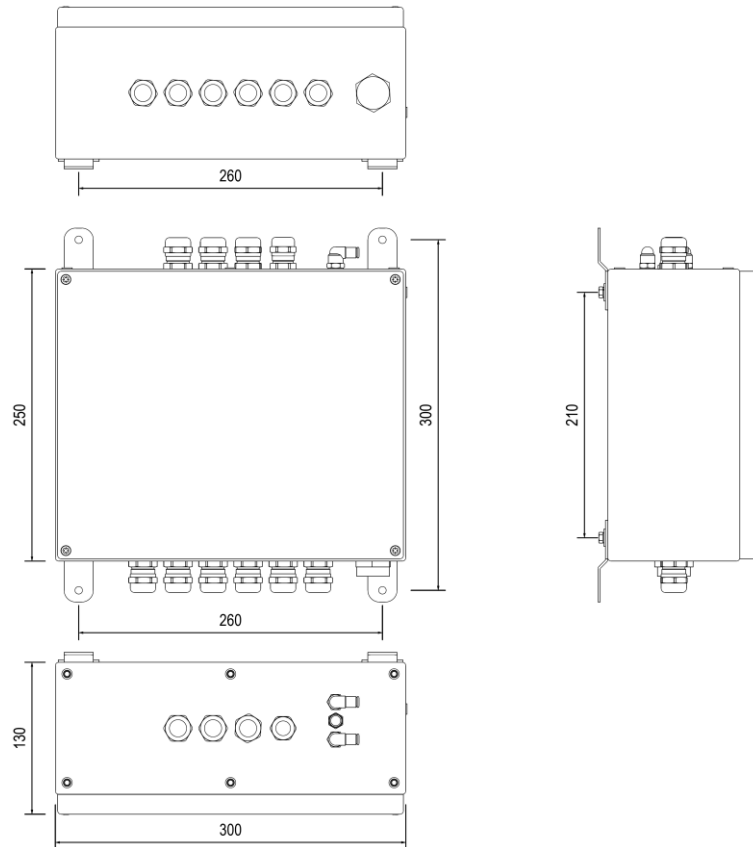

Image not true to scale.

#### 13.3.2 Pressure outlet, 17-51P3-1603

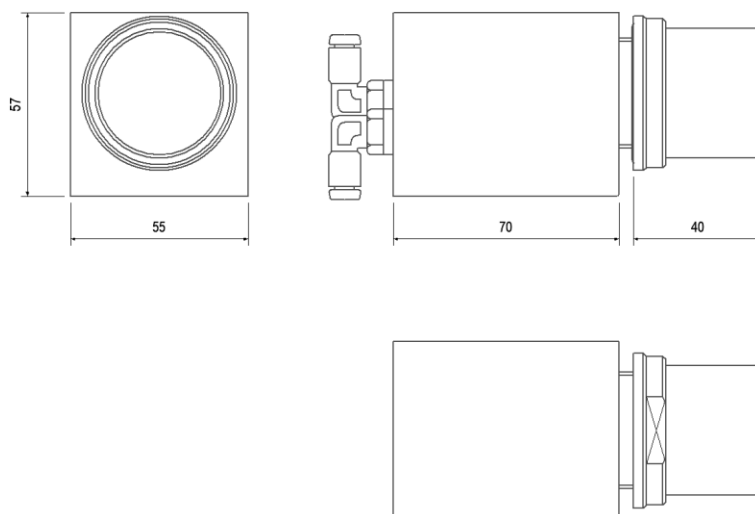

Image not true to scale.

## 13.4 Software packages used



The service area of hardware / software of the control unit  
APEX uses the freeware freeRTOS



# 14 Declaration of conformity

## 14.1 Ex p control unit APEX, Type 07-37A2-\*1\*1/\*\*\*\*

EU Konformitätserklärung  
EU Declaration of Conformity  
Déclaration UE de conformité  
N<sup>o</sup> 01-37A2-7C0001\_A

**BARTEC**

Wir	We	Nous
<b>BARTEC GmbH</b> Max-Eyth-Straße 16 97980 Bad Mergentheim Germany		
erklären in alleiniger Verantwortung, dass das Produkt <b>Ex p Kontrolleinheit</b>	declare under our sole responsibility that the product <b>Ex p control unit</b>	attestons sous notre seule responsabilité que le produit <b>Unité de contrôle Ex p</b>

**Typ 07-37A2-\*1\*1/\*\*\*\* APEX<sup>py</sup> und 07-37A2-\*2\*1/\*\*\*\* APEX<sup>px</sup>**  
**Type 07-37A2-\*1\*1/\*\*\*\* APEX<sup>py</sup> and 07-37A2-\*2\*1/\*\*\*\* APEX<sup>px</sup>**

auf das sich diese Erklärung bezieht den Anforderungen der folgenden <b>Richtlinien (RL)</b> entspricht <b>ATEX-Richtlinie 2014/34/EU</b> <b>EMV-Richtlinie 2014/30/EU</b> <b>RoHS-Richtlinie 2011/65/EU</b> <b>WEEE-Richtlinie 2012/19/EU</b> und mit folgenden Normen oder normativen Dokumenten übereinstimmt	to which this declaration relates is in accordance with the provision of the following <b>directives (D)</b> <b>ATEX-Directive 2014/34/EU</b> <b>EMC-Directive 2014/30/EU</b> <b>RoHS-Directive 2011/65/EU</b> <b>WEEE-Directive 2012/19/EU</b> and is in conformity with the following standards or other normative documents	se référant à cette attestation correspond aux dispositions des <b>directives (D)</b> suivantes <b>Directive ATEX 2014/34/UE</b> <b>Directive CEM 2014/30/UE</b> <b>Directive RoHS 2011/65/UE</b> <b>Directive WEEE 2012/19/UE</b> et est conforme aux normes ou documents normatifs ci-dessous
<b>EN IEC 60079-0:2018/AC:2020</b> <b>EN 60079-2:2014</b> <b>EN IEC 60079-7:2015/A1:2018</b> <b>EN 60079-11:2012</b> <b>EN 60079-18:2015/A1:2017</b> <b>EN 60079-31:2014</b> <b>EN 61010-1:2010</b>	<b>EN 61000-6-4:2007 +A1:2011</b> <b>EN 61000-3-2:2014</b> <b>EN 61000-3-3:2013</b> <b>EN 61326-1:2013</b> <b>EN 62061:2005 + Cor.:2010 + A1:2013 + A2:2015</b> <b>EN ISO 13849-1:2015</b> <b>EN ISO 13849-2:2012</b>	
Verfahren der EU-Baumusterprüfung / Benannte Stelle	Procedure of EU-Type Examination / Notified Body	Procédure d'examen UE de type / Organisme Notifié

**BVS 19 ATEX E 015 X**

**0158, DEKRA Testing and Certification GmbH, 44809 Bochum**

**CE 0044**

Bad Mergentheim, 30.06.2021

*i. V. Jens Schurwanz*  
i.V. Jens Schurwanz  
Global Product Line Manager  
Ex p

*i. A. Steffen Mika*  
i.A. Steffen Mika  
Certification Manager

## **BARTEC**

BARTEC GmbH  
Max-Eyth-Str. 16  
97980 Bad Mergentheim  
Germany

Phone: +49 7931 597 0  
info@bartec.com

**bartec.com**